

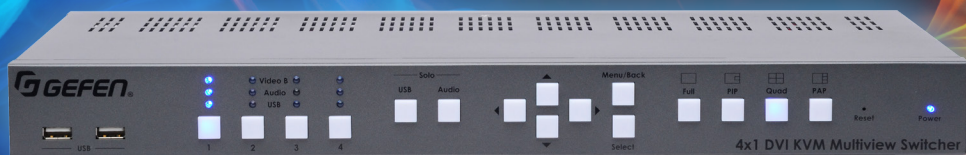

4x1 DVI KVM Multiview Switcher

EXT-DVIK-MV-441

User Manual



Release A2

Important Safety Instructions

1. Read these instructions.
2. Keep these instructions.
3. Heed all warnings.
4. Follow all instructions.
5. Do not use this unit near water.
6. Clean only with a dry cloth.
7. Do not block any ventilation openings. Install in accordance with the manufacturer's instructions.
8. Do not install or place this unit near any heat sources such as radiators, heat registers, stoves, or other apparatus (including amplifiers) that produce heat.
9. Do not defeat the safety purpose of the polarized or grounding-type plug. A polarized plug has two blades with one wider than the other. A grounding type plug has two blades and a third grounding prong. The wide blade or the third prong are provided for your safety. If the provided plug does not fit into your outlet, consult an electrician for replacement of the obsolete outlet.
10. Protect the power cord from being walked on or pinched particularly at plugs, convenience receptacles, and the point where they exit from the unit.
11. Only use attachments/accessories specified by the manufacturer.
12. To reduce the risk of electric shock and/or damage to this unit, never handle or touch this unit or power cord if your hands are wet or damp. Do not expose this unit to rain or moisture.
13. Unplug this unit during lightning storms or when unused for long periods of time.
14. Refer all servicing to qualified service personnel. Servicing is required when the unit has been damaged in any way, such as power-supply cord or plug is damaged, liquid has been spilled or objects have fallen into the unit, the unit has been exposed to rain or moisture, does not operate normally, or has been dropped.
15. Batteries that may be included with this unit and/or accessories should never be exposed to open flame or excessive heat. Always dispose of used batteries according to the instructions.

Warranty Information

Gefen warrants the equipment it manufactures to be free from defects in material and workmanship.

If equipment fails because of such defects and Gefen is notified within two (2) years from the date of shipment, Gefen will, at its option, repair or replace the equipment, provided that the equipment has not been subjected to mechanical, electrical, or other abuse or modifications. Equipment that fails under conditions other than those covered will be repaired at the current price of parts and labor in effect at the time of repair. Such repairs are warranted for ninety (90) days from the day of reshipment to the Buyer.

This warranty is in lieu of all other warranties expressed or implied, including without limitation, any implied warranty or merchantability or fitness for any particular purpose, all of which are expressly disclaimed.

1. Proof of sale may be required in order to claim warranty.
2. Customers outside the US are responsible for shipping charges to and from Gefen.
3. Copper cables are limited to a 30 day warranty and cables must be in their original condition.

The information in this manual has been carefully checked and is believed to be accurate. However, Gefen assumes no responsibility for any inaccuracies that may be contained in this manual. In no event will Gefen be liable for direct, indirect, special, incidental, or consequential damages resulting from any defect or omission in this manual, even if advised of the possibility of such damages. The technical information contained herein regarding the features and specifications is subject to change without notice.

For the latest warranty coverage information, refer to the Warranty and Return Policy under the Support section of the Gefen Web site at www.gefen.com.

Technical Support

(818) 772-9100 (800) 545-6900
8:00 AM to 5:00 PM Monday - Friday, Pacific Time

Fax

(818) 772-9120

Email

support@gefen.com

Web

<http://www.gefen.com>

Mailing Address

Gefen, LLC
c/o Customer Service
20600 Nordhoff St.
Chatsworth, CA 91311

Product Registration

Register your product here: <http://www.gefen.com/kvm/Registry/Registration.jsp>

Operating Notes

- In order to operate the 4x1 DVI KVM Multiview Switcher using a mouse, a 3-button mouse is required.
- When controlling the 4x1 DVI KVM Multiview Switcher using a keyboard, the default hotkey is the Scroll Lock key. To define a different hotkey, refer to the section [Defining the Hotkey \(page 40\)](#).
- The display connected to Video A will support multiple sources. The display connected to Video B will only be user to display the currently selected source and connect display multiple sources.

4x1 DVI KVM Multiview Switcher is a trademark of Gefen, LLC.

© 2014 Gefen, LLC. All Rights Reserved. All trademarks are the property of their respective owners.

Gefen, LLC reserves the right to make changes in the hardware, packaging, and any accompanying documentation without prior written notice.



This product uses UL or CE listed power supplies.

Features

- Dual Screen Workstation Set-up: Full Screen and Multiview
- 4 Multiview Modes: Full Screen, Quad-View, PIP (Picture-In-Picture), and PAP (Picture-And-Picture)
- Input and Output resolutions up to 1920 x 1200 (WUXGA) and 1080p Full HD
- HDCP 1.4 Compliant
- Controlled via front panel, keyboard/mouse, and RS-232.
- Comprehensive and easy-to-use On Screen Display.
- Supports cascading of up to 8 units to create a 32 computer system controlled from one keyboard/mouse workstation.
- Firmware update via USB port using the Gefen Syner-G™ software
- Locking power supply connector
- Rack-mountable using the included brackets



Packing List

The 4x1 DVI KVM Multiview Switcher ships with the items listed below. If any of these items are not present in the box when you first open it, immediately contact your dealer or Gefen.

- 1 x 4x1 DVI KVM Multiview Switcher
- 1 x 12V DC Power Supply
- 1 x IEC AC power cord
- 2 x Rack Ears
- 6 x Rack Ear-to-unit attachment screws
- 4 x Self-adhesive bump-ons
- 1 x Quick-Start Guide

1 Getting Started

Introduction.....	2
Front Panel.....	2
Back Panel.....	4
Installation.....	7
Connection Instructions.....	7
Sample Wiring Diagram.....	9

2 Basic Operation

Powering the Switcher.....	12
Display Nomenclature.....	14
Main and Auxiliary Displays.....	14
Using the Auxiliary Display.....	15
Windows.....	16
Display Modes.....	17
Selecting the Display Mode.....	18
Switching Sources.....	19
Full Mode.....	19
PIP (Picture-In-Picture) Mode.....	22
Quad Mode.....	26
PAP (Picture-And-Picture) Mode.....	30
Solo Buttons.....	33
Independent USB Switching.....	33
Independent Audio Switching.....	34
PIP & PAP Modes.....	36
Zoom and Position (PIP Only).....	36
Window Management in PAP Mode.....	37
OSD Menu.....	39
Accessing the Menu System.....	39
Defining the Hotkey.....	40
Linking / Unlinking USB.....	42
Linking / Unlinking Audio.....	44
Linking / Unlinking Video B.....	46
OSD Timeout.....	48
Titlebar Timeout.....	50
Show PC Name.....	52
Show Video Signal.....	54
Output Resolution.....	56
Shrink Control.....	58
EDID Mode.....	60
One-Click Switching.....	62
PIP Scan Period.....	64
Load Factory Default.....	66

Read Monitor EDID	68
Upgrade Firmware	70
Changing the Source Name	71

3 Advanced Operation

Cascading	76
RS-232 Interface	81
RS-232 Interface	81
RS-232 Settings	81
Commands	82

4 Appendix

Default Settings	116
OSD	116
Hotkeys	117
Firmware Upgrade	119
Using the USB Port	119
Using the RS-232 Port	120
Using the OSD	121
Specifications	122

4x1 DVI KVM Multiview Switcher

1 Getting Started

Front Panel

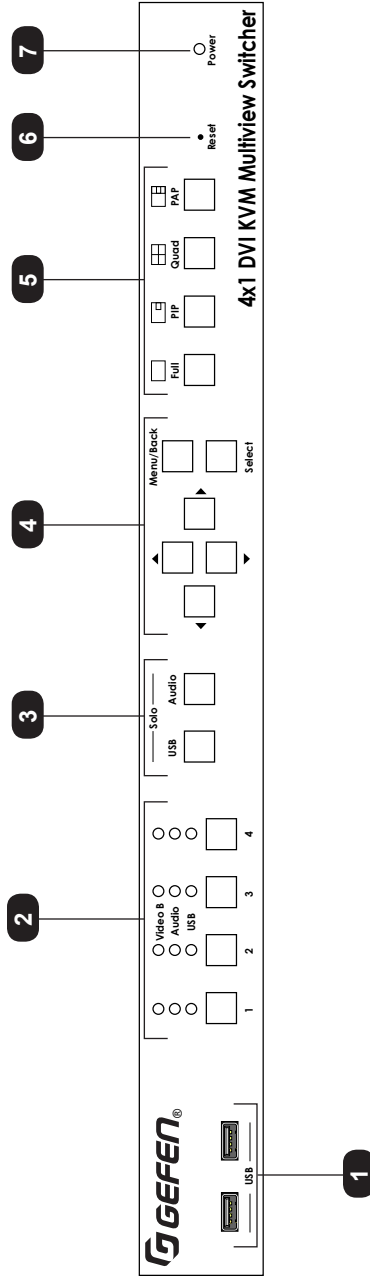

ID	Name	Description
1	USB	Connect a USB device to each of these USB ports.
2	Source selection (1 - 4)	Press these buttons to select the video / audio / USB source. See Switching Sources (page 19) for more information.
3	Solo (USB, Audio)	These buttons allow separate (unlinked) selection of USB an audio sources. When either button is illuminated, the Source selection (1 - 4) buttons select the USB or audio source instead of the Video A source.
4	OSD buttons	Use these buttons to control the built-in On-Screen Display (OSD). See OSD Menu (page 39) for more information.
5	Display mode	Press these buttons to select the desired display mode. See Selecting the Display Mode (page 18) for more information.
6	Reset	Use a sharp-pointed object to depress this button and reset the unit.
7	Power	This LED indicator will glow solid blue when power is applied to the unit.

Back Panel

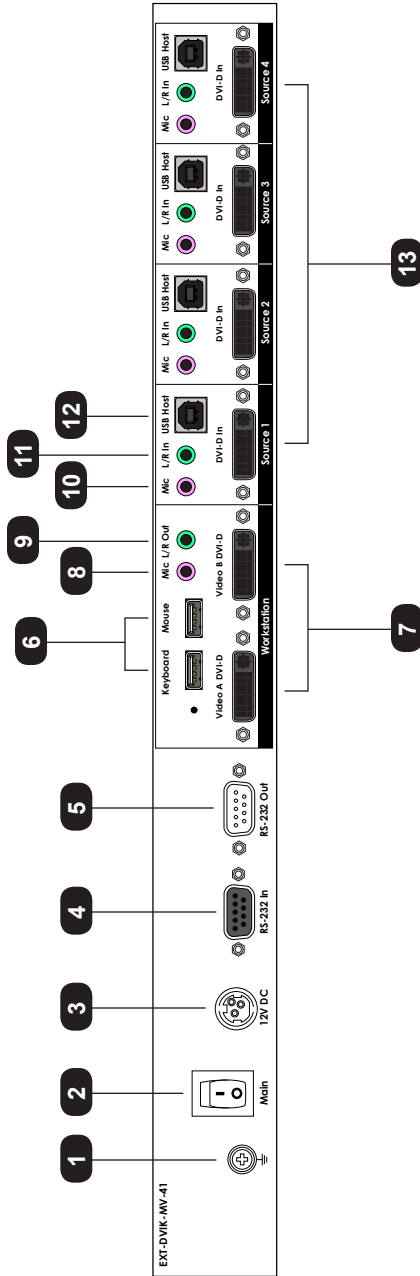

ID	Name	Description
1	Grounding terminal	Connect a grounding wire from this terminal to an approved Earth ground.
2	Main	Press this switch to power-on or power-off the unit.
3	12V DC	Connect the included power supply from this power receptacle to an available electrical outlet.
4	RS-232 In	Connect an RS-232 cable from this power to an RS-232 controller.
5	RS-232 Out	Connect an RS-232 cable from this port to the RS-232 device to be controlled.
6	Keyboard / Mouse	Connect a keyboard and mouse to these USB ports.
7	Video A / Video B	Connect a DVI cable from each of these ports to a DVI display. The Video A port is the <i>main</i> display and supports multiple windows. Video B is the auxiliary display. See Display Nomenclature (page 14) for more information.
8	Mic (Workstation)	Connect a 3.5mm mini-stereo cable from this jack to the Mic jack on the workstation computer.
9	L/R Out	Connect a 3.5mm mini-stereo cable from this jack to a pair of powered speakers.
10	Mic (Source 1 - Source 4)	Connect a 3.5mm mini-stereo cable from this jack to the Mic jack on the source computer.
11	L/R In (Source 1 - Source 4)	Connect a 3.5mm mini-stereo cable from this jack to the Line Out jack on the computer.

(continued on next page)

ID	Name	Description
12	USB Host (Source 1 - Source 4)	Use USB cables to connect up to four computers to these USB ports.
13	DVI-D In (Source 1 - Source 4)	Connect up to four computer sources to these ports using DVI cables.

Connection Instructions

▶ Video Source

1. Use DVI cables to connect a DVI source (e.g. computer) to each one of the **DVI-D In** ports (**Source 1 - Source 4**) on the rear panel. Note that only DVI-D (digital) sources are supported.

▶ Audio Source

2. Connect 3.5mm mini-stereo cables from the audio output on the computer to the **L/R In** jacks on the rear panel.

▶ USB (Host)

3. Connect USB cables from each computer to the **USB Host** ports on the rear panel.

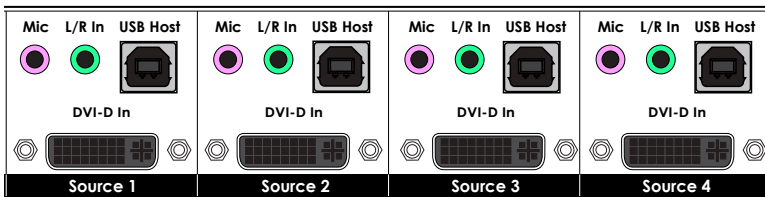

▶ Displays

4. Connect a DVI display to each of the Workstation ports (**Video A DVI-D** and **Video B DVI-D**). Note that the display connected to **Video A** will support multiple sources. The display connected to **Video B** will only be used to display the currently selected source and cannot display multiple sources.

▶ Mouse & Keyboard (Switcher Control)

5. Connect a computer keyboard to the **Keyboard** USB port. Connect a mouse device to the **Mouse** USB port. To take advantage of all the control features, we recommend a mouse that has a scroll wheel.

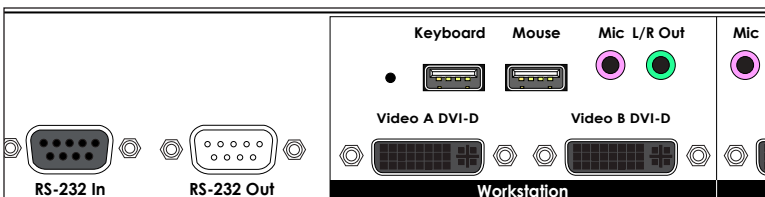

► **Audio Output**

6. Connect a 3.5mm mini-stereo cable from the **L/R Out** jack to a pair of powered speakers.

► **RS-232 (optional)**

7. Connect an RS-232 cable from the automation control device to the **RS-232 In** port.
8. Connect another RS-232 cable from the RS-232 Out port to another 4x1 DVI KVM Multiview Switcher. Up to eight 4x1 DVI KVM Multiview Switchers can be daisy-chained together. See [Cascading \(page 76\)](#) for more information.

► **USB (computer control)**

9. Connect up to two USB devices (e.g. keyboard, mouse, USB drive, etc.) to these ports. Depending upon which source is selected, the USB device can be used by a different computer.

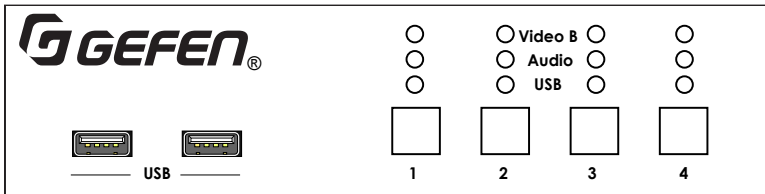

► **Grounding**

9. Connect a grounding wiring from the grounding terminal to an approved Earth ground.

► **Power**

10. Connect the included power supply to the **12V DC** power receptacle on the 4x1 DVI KVM Multiview Switcher.
11. Connect the included AC cable from the power receptacle to an available electrical outlet.

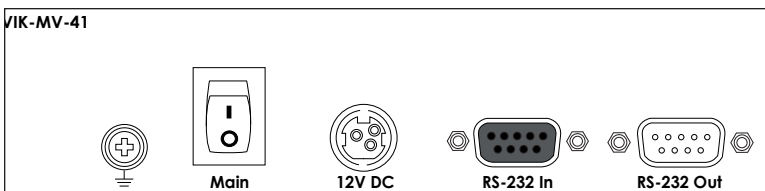

Sample Wiring Diagram

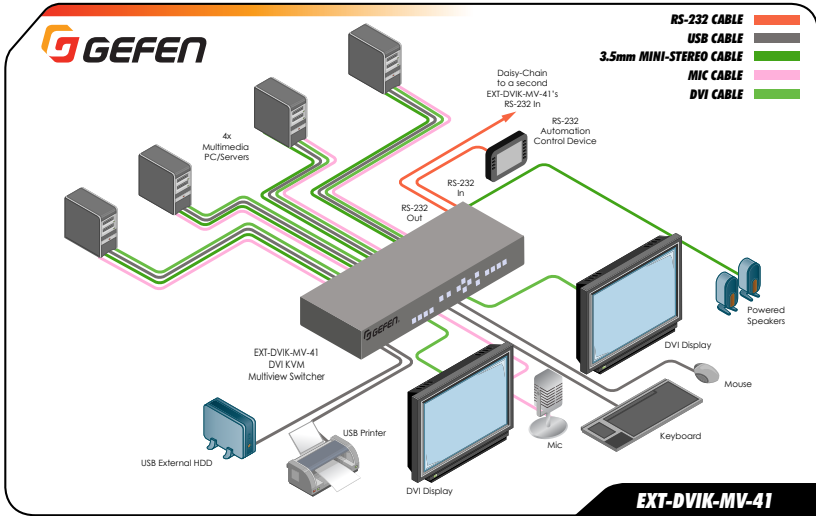

4x1 DVI KVM Multiview Switcher

2 Basic Operation

Powering the Switcher

1. Before powering-on the 4x1 DVI KVM Multiview Switcher, make sure all devices and the power supply are connected, as outlined under [Installation](#) (page 7).

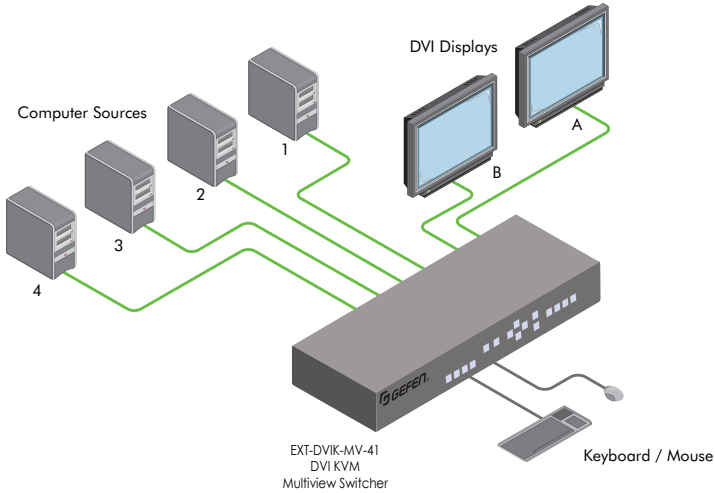

2. Press the **Main** (power) button on the back panel so that the top-portion, marked with an "I", is flush with the back panel

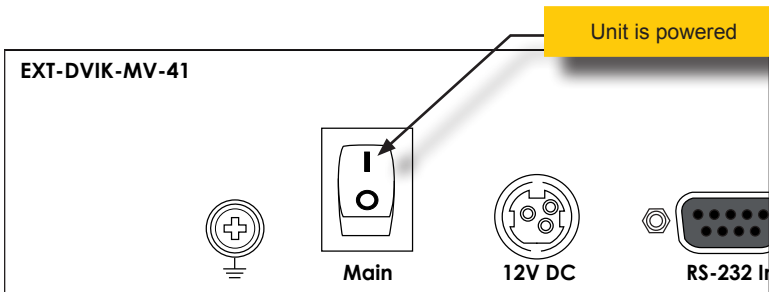

3. The Power indicator on the front of the unit will glow solid blue. In addition, both the **Quad** display mode and **Source 1** buttons will be selected (illuminated), as shown:

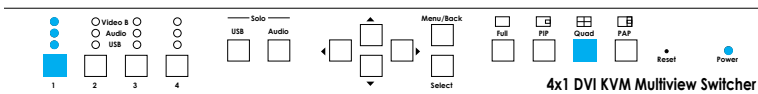

- Power-on all computer sources. The image from each source will be combined on a single screen on the display connected to **Video A**. The currently selected source (Source 1, by default) will be shown on the display connected to **Video B**.

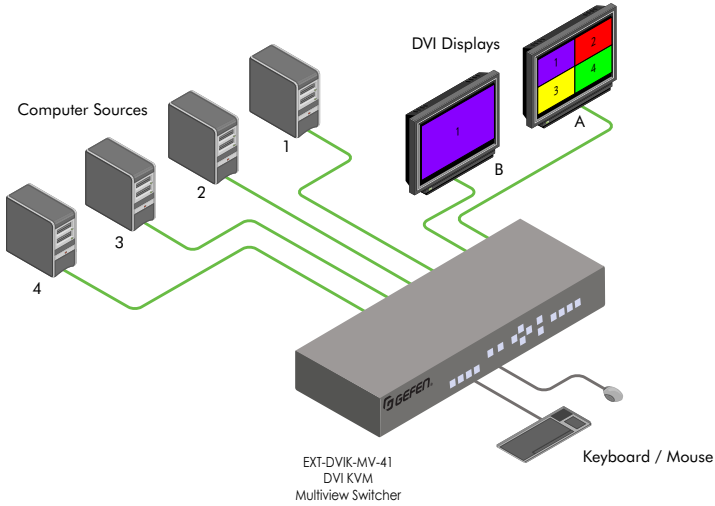

The window layout for **Quad** mode, on **Video A**, is arranged as follows:

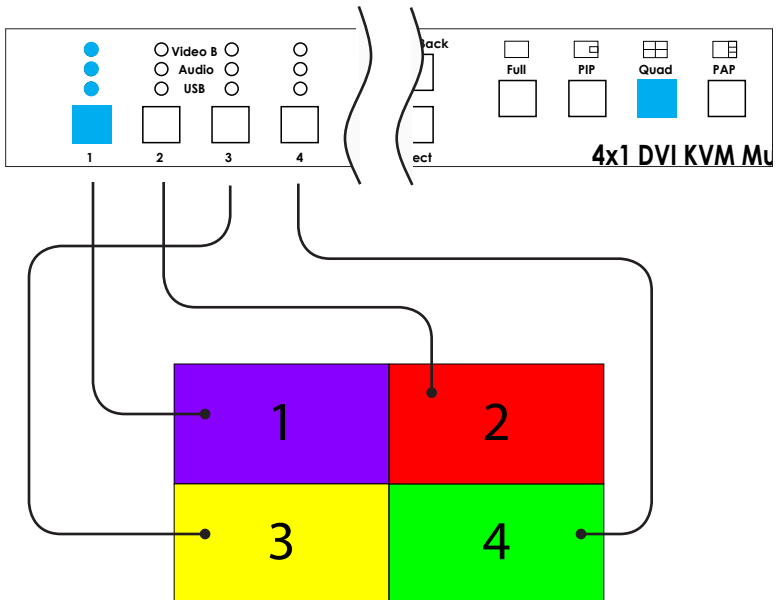

Main and Auxiliary Displays

The 4x1 DVI KVM Multiview Switcher uses has two output ports on the rear panel: **Video A** and **Video B**. The **Video A** port is used to display the video modes (Full, PIP, Quad, and PAP) and is referred to as the *main* display.

The **Video B** port is used to display the currently selected source and is referred to as the *auxiliary* display. Each of these displays serve a unique function and cannot be changed. For example, the *auxiliary* display can *never* display more than one source at a time.

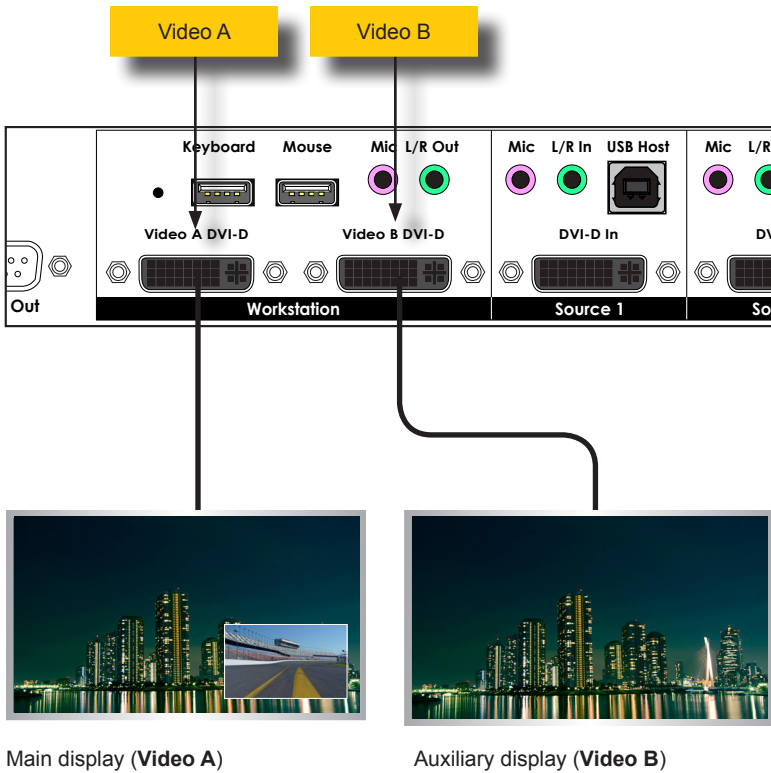

Information
Video A is scaled and the resolution can be set using the #set_output command. Video B is pass-through and cannot be scaled.

Using the Auxiliary Display

The auxiliary display always displays the currently selected source. In this example, we are in PIP mode and the **Source 1** button is currently selected. **Source 1** is displayed on the *auxiliary* display (**Video B**).

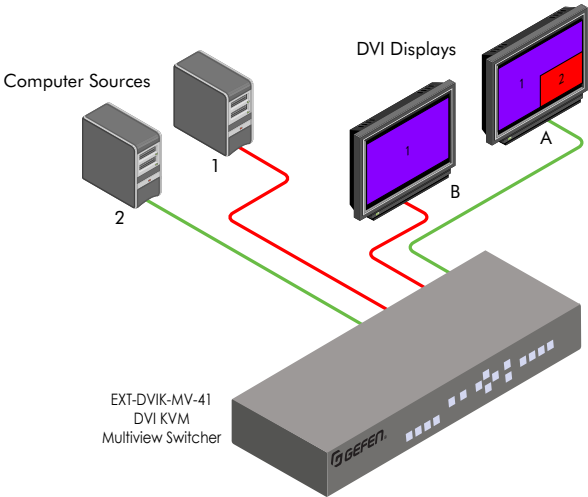

Now, we'll switch to **Source 2**. As expected, **Source 2** is now displayed on the *auxiliary* display (**Video B**). **Source 2** is also displayed in the *main* window of the *main* display (**Video A**). PIP mode and other modes will be covered in greater detail in a later section.

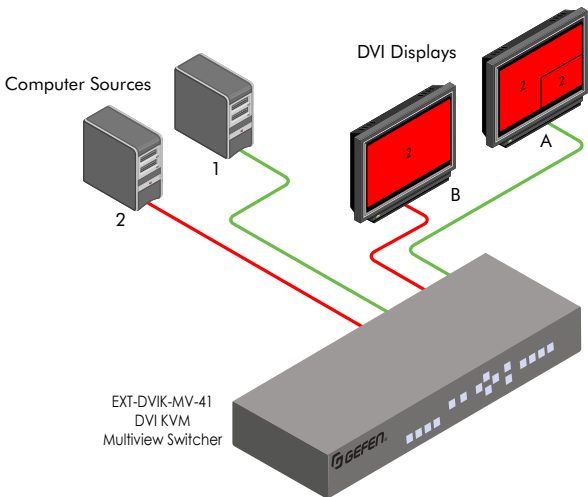

Windows

When we talk about a *window*, we are referring to an individual source (image) within one of the multiple-source display modes: PIP, Quad, or PAP.

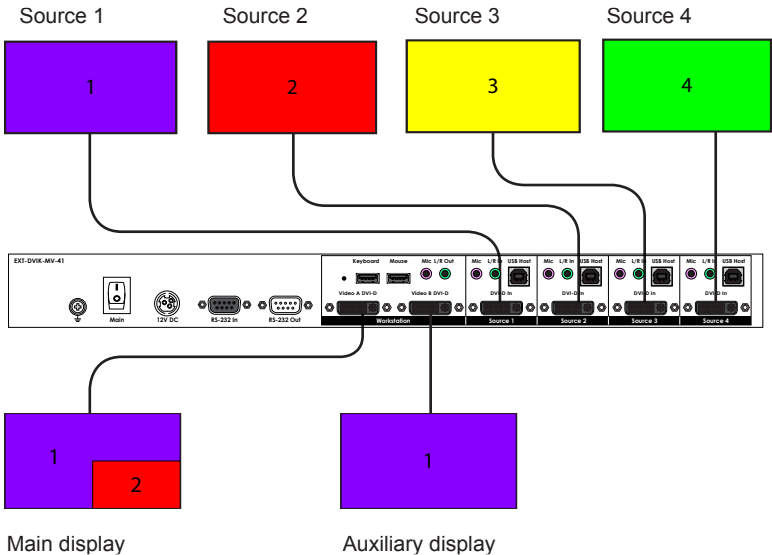

By definition, a *subordinate* window can always be switched with a *main* window. PIP and PAP modes contain both *main* and *subordinate* windows.

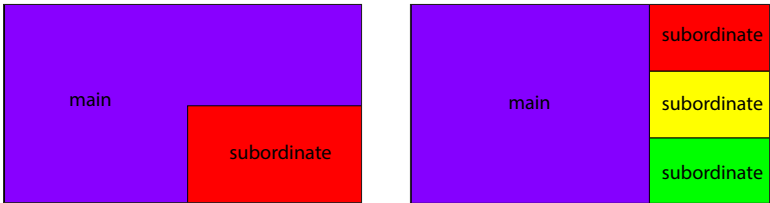

Full mode contains a single window. Quad mode contains four *fixed* windows:

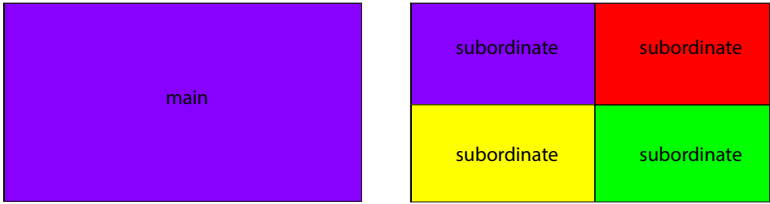

The **Video A** port on the 4x1 DVI KVM Multiview Switcher provides the ability to display up to four DVI sources, simultaneously. The 4x1 DVI KVM Multiview Switcher comes with 4 display modes: **Full**, **PIP** (Picture-In-Picture), **Quad**, and **PAP** (Picture-And-Picture).

Full

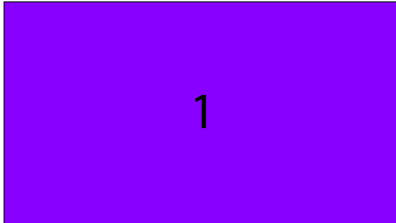

Displays a full-screen image of the selected source (1 - 4).

PIP (Picture-In-Picture)

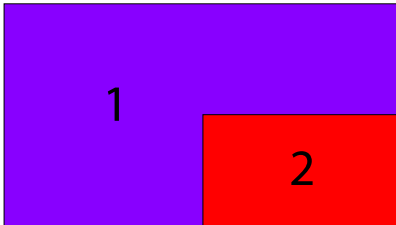

Displays any two sources, in separate windows, on a single screen: The *main* (larger) window and the *subordinate* (smaller) window. The *subordinate* window can be re-sized and repositioned. See [PIP & PAP Modes \(page 36\)](#) for details.

Quad

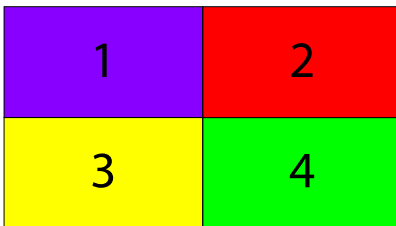

Displays all four sources on a single screen. Each window displays a single source. The window order *cannot* be changed.

PAP (Picture-And-Picture)

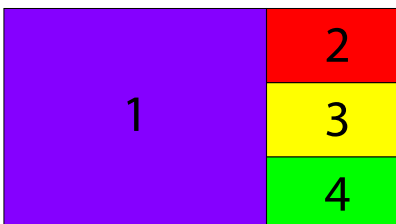

Displays all four sources on a single screen: The *main* (larger) window and 3 *subordinate* (smaller) windows. The *main* window can “swapped” with any of the *subordinate* windows.

Selecting the Display Mode

The 4x1 DVI KVM Multiview Switcher comes with 4 display modes. Of these 4 display modes, both PIP and PAP display modes allow you to switch the main window to a subordinate window. In the case of PIP mode, the subordinate window can be repositioned to any location on the display and can be re-sized, if desired.

There are several ways to switch to a display mode. The most straightforward method is to use the buttons on the front panel. In the next section, we will cover these methods and how to switch the sources within each display mode.

Full

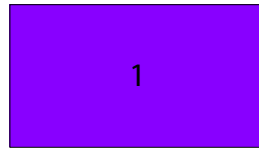
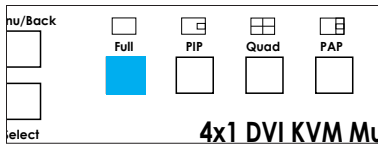

PIP (Picture-In-Picture)

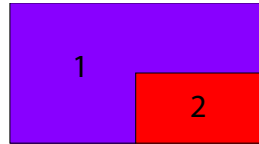
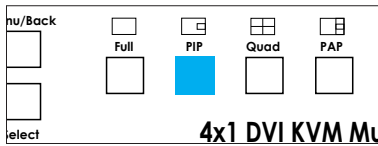

Quad

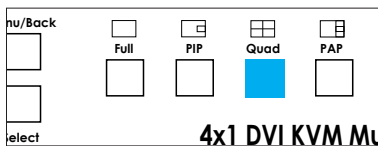

PAP (Picture-And-Picture)

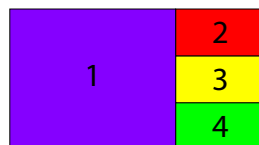
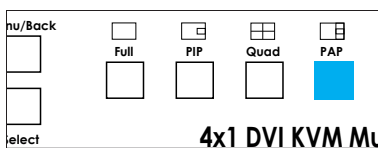

Switching sources can be accomplished by using the Source buttons on the front panel, the mouse, function keys, or using predefined hot-key bindings. Hotkey assignments can be user-defined as needed. In order to operate the Switcher using a mouse, a 3-button mouse is *required*.

Full Mode

► Front panel

1. Press the Full button to enter Full mode.
2. Press the desired source button (1 - 4).
3. The currently selected source will be displayed on both Video A and Video B.

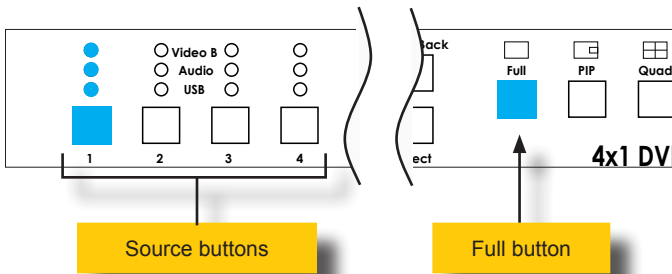

► Mouse

1. Click the middle mouse button / wheel to display the mode menu on the **Video A** display.
2. Left-click the Full mode icon.
3. A drop-down menu will be displayed.



- The currently selected source will be indicated by a “dash”, as shown:

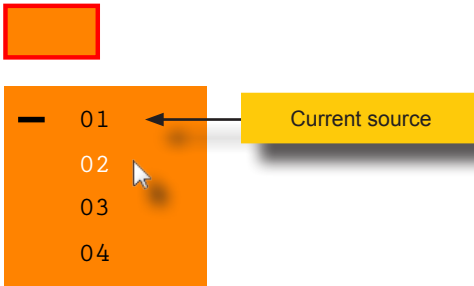

- Left click the desired input (1 - 4) from the drop-down menu.
- The selected source will be shown on both **Video A** and **Video B**.
- Click the middle mouse button / wheel to dismiss the Display Mode menu.

► Keyboard

- Press the following keys, in sequence, on the computer keyboard.

The default hotkey is the Scroll Lock key. To reassign the hotkey refer to [Defining the Hotkey \(page 40\)](#) for more information.

hotkey + *hotkey* + **F** + X

Where X is a number on the keyboard from 1 to 4. This number represents the source to be displayed.

For example, to switch to Full mode and display the source connected to Source 3, use the following keystrokes:

hotkey + *hotkey* + **F** + **3**

- The selected source will be shown on both **Video A** and **Video B**.

► OSD

1. Press the following keys, in sequence, on the computer keyboard.

The default hotkey is the Scroll Lock key. To reassign the hotkey refer to [Defining the Hotkey \(page 40\)](#) for more information.



2. The OSD will be displayed.

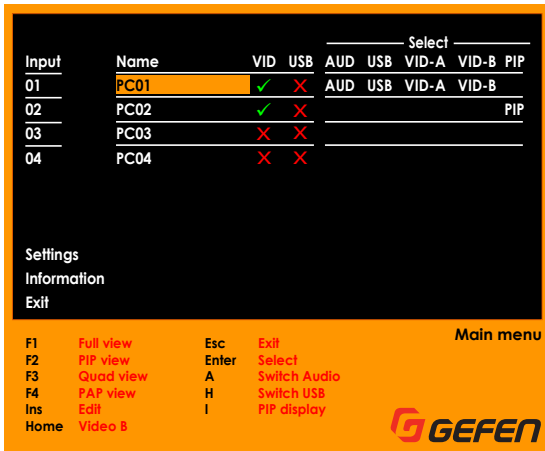

3. Press the **F1** key.
4. The selected source will be shown on both **Video A** and **Video B**.
5. Press the **Esc** key to immediately exit the OSD.
6. Use the keyboard, mouse, or front panel buttons to set the source for the *main* window and the *subordinate* window.
7. For more information about OSD features, refer to [OSD Menu \(page 39\)](#).

PIP (Picture-In-Picture) Mode

► Front panel

1. Press the **PIP** button to enter PIP mode.
2. Press the desired source button (1 - 4).
3. The selected source will be shown on both Video B and in the *main* window on Video A.

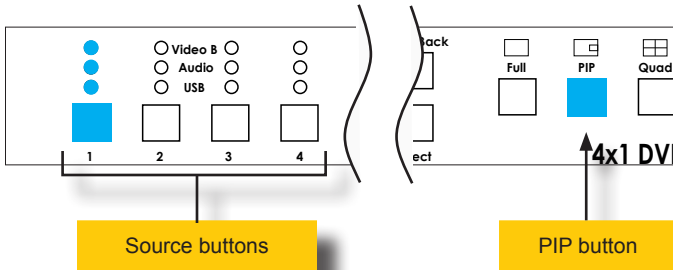

4. Once the desired source for the *main* window is selected, press the **PIP** button again to select the *subordinate* window. When the **PIP** button is pushed again, it will blink rapidly.

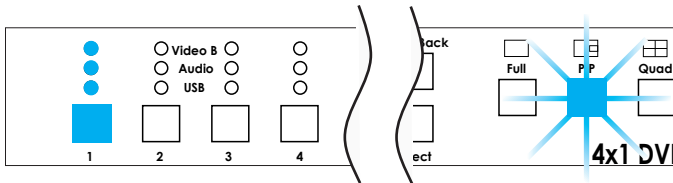

5. Select the desired source for the *subordinate* window using the source buttons.
6. The selected source will be on both Video B and in the *subordinate* window of Video A.
7. Press the **PIP** button a third time to complete the source selection process.
8. The **PIP** button will glow solid blue.
9. The subordinate window can be re-sized and repositioned on Video A. See [PIP & PAP Modes \(page 36\)](#) for more information.

► Mouse

1. Click the middle mouse button / wheel to display the mode menu on the **Video A** display.
2. Left-click the **PIP** mode icon.
3. A drop-down menu will be displayed. The drop-down menu will be separated into two panels, as shown.

The top panel controls the *main* window. The bottom panel controls the *subordinate* window.

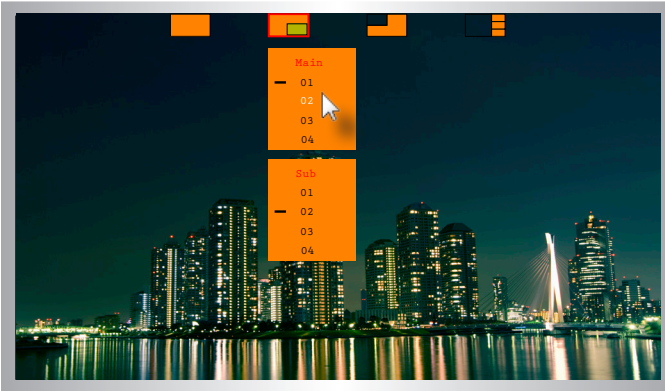

4. The currently selected source, for each window, will be indicated by a “dash”, as shown:

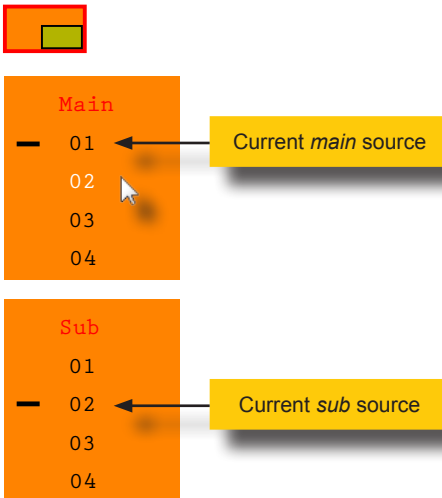

5. Left click the desired input (1 - 4) from the drop-down menu for the *main* window on **Video A**. The selected source will also be displayed on **Video B**.
6. Left click the desired input (1 - 4) from the drop-down menu for the *subordinate* window on **Video A**. The selected source will also be displayed on **Video B**.
7. The selected sources, for each window, will be displayed on Video A.
8. Click the middle mouse button / wheel to dismiss the Display Mode menu.

► Keyboard

1. To set the source for the *main* window, press the following keys, in sequence, on the computer keyboard.

The default hotkey is the Scroll Lock key. To reassign the hotkey refer to [Defining the Hotkey \(page 40\)](#) for more information.

hotkey + **hotkey** + **I** + X

2. To set the source for the *subordinate* window, press the following keys, in sequence, on the computer keyboard:

hotkey + **hotkey** + **P** + X

In both cases, X represents the number of the source to be displayed.

For example, to switch to PIP mode and set Source 1 to the *main* window and Source 4 to the *subordinate* window, use the following keystrokes:

hotkey + **hotkey** + **I** + **1**

hotkey + **hotkey** + **P** + **4**

The *main* and *subordinate* windows can be assigned in any order.

► OSD

1. Press the following keys, in sequence, on the computer keyboard.

The default hotkey is the Scroll Lock key. To reassign the hotkey refer to [Defining the Hotkey \(page 40\)](#) for more information.



2. The OSD will be displayed.

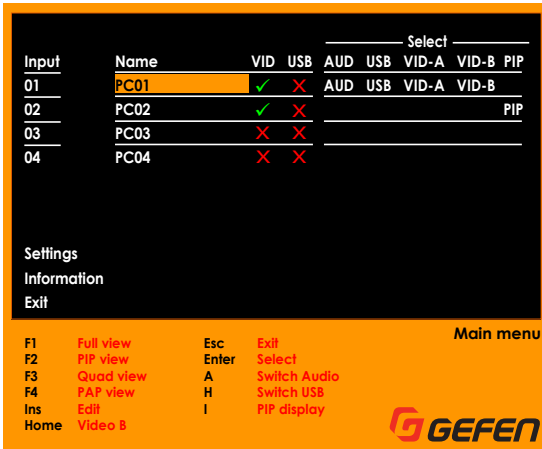

3. Press the **F2** key.
4. Press the **Esc** key to immediately exit the OSD.
5. Use the keyboard, mouse, or front panel buttons to set the source for the *main* window and the *subordinate* window.
6. For more information about OSD features, refer to [OSD Menu \(page 39\)](#).

Quad Mode

Quad mode allows four all sources (Source 1 - Source 4) to be displayed on **Video A**. The order and size of each window *cannot* be changed. Each window is associated with a source: Window 1 = Source 1, Window 2 = Source 2, and so on.

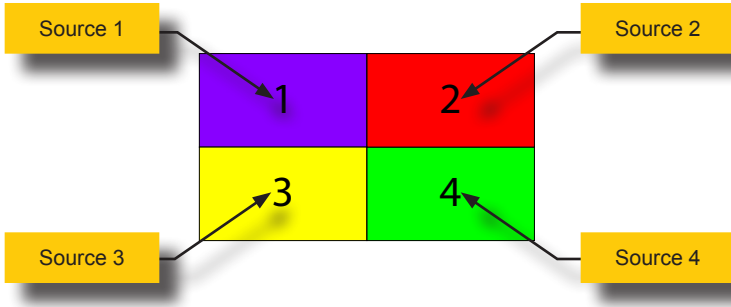

The currently selected source will always be highlighted with a red outline. In the illustration, below, Source 1 is the currently selected source.

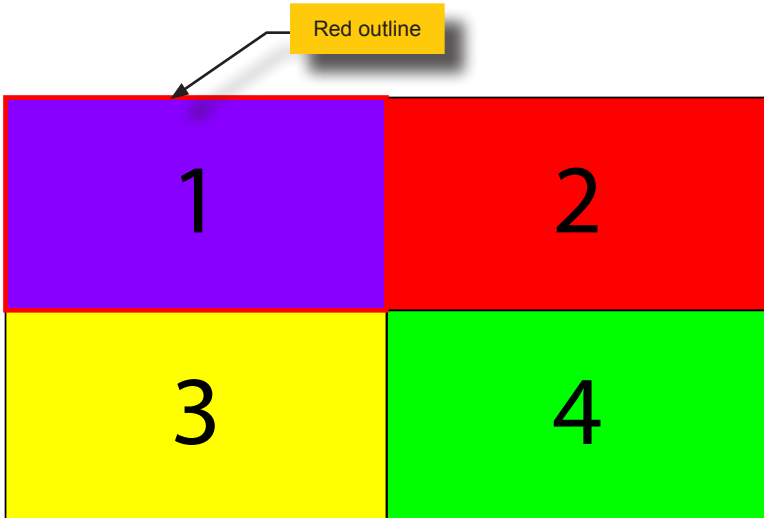
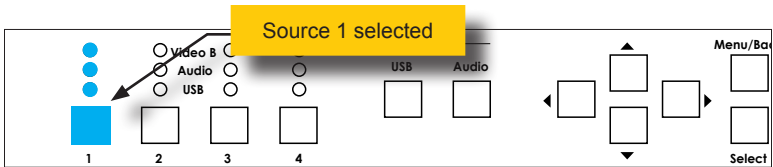

► Front panel

1. Press the **Quad** button.
2. Press the desired source button (1 - 4).
3. The selected source will be displayed on both **Video B** and in the associated window of **Video A**.

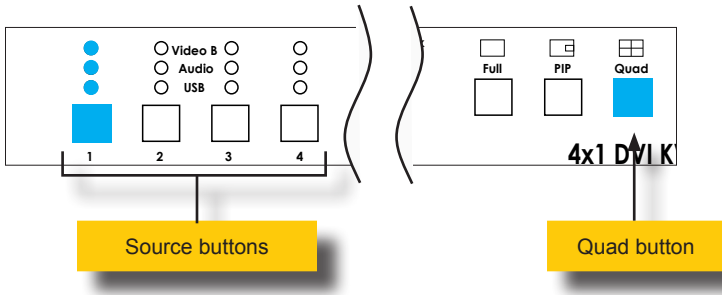

► Mouse

1. Click the middle mouse button / wheel to display the mode menu on the **Video A** display.
2. Left-click the **Quad** mode icon.
3. A drop-down menu will be displayed.

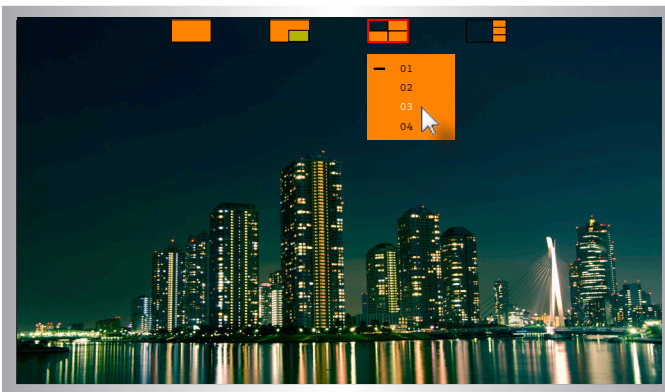

- The currently selected source, for each window, will be indicated by a “dash”, as shown:

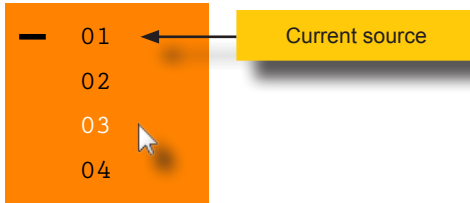

- Left click the desired input (1 - 4) from the drop-down menu.
- The selected source will also be displayed on both **Video B** and in the associated window in **Video A**.
- Click the middle mouse button / wheel to dismiss the Display Mode menu.

► Keyboard

- Press the following keys, in sequence, on the computer keyboard:

The default hotkey is the Scroll Lock key. To reassign the hotkey refer to [Defining the Hotkey \(page 40\)](#) for more information.



Where *X* is a number on the keyboard from 1 to 4. This number represents the source to be selected.

When a source is selected, it will appear on both **Video B** and in the associated window of **Video A**.

For example, to switch to Quad mode and display the source connected to Source 3, use the following keystrokes:



► OSD

1. Press the following keys, in sequence, on the computer keyboard.

The default hotkey is the Scroll Lock key. To reassign the hotkey refer to [Defining the Hotkey \(page 40\)](#) for more information.



2. The OSD will be displayed.

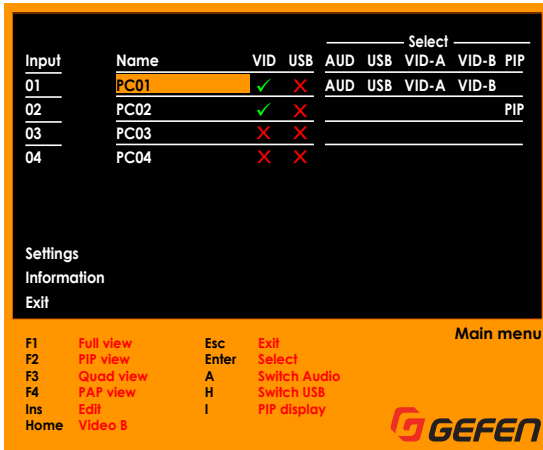

3. Press the **F3** key.
4. Press the **Esc** key to immediately exit the OSD.
5. For more information about OSD features, refer to [OSD Menu \(page 39\)](#).

PAP (Picture-And-Picture) Mode

► Front panel

1. Press the **PAP** button.
2. Press the desired source button (1 - 4).
3. The selected source will be displayed on both **Video B** and in the *main* window of **Video A**. The *subordinate* windows will display the remaining sources.

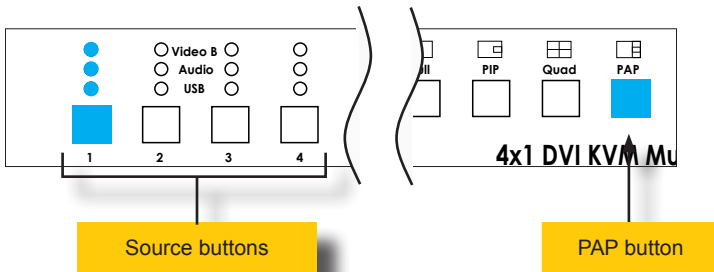

► Mouse

1. Click the middle mouse button / wheel to display the mode menu on the **Video A** display.
2. Left-click the **PAP** mode icon.
3. A drop-down menu will be displayed.

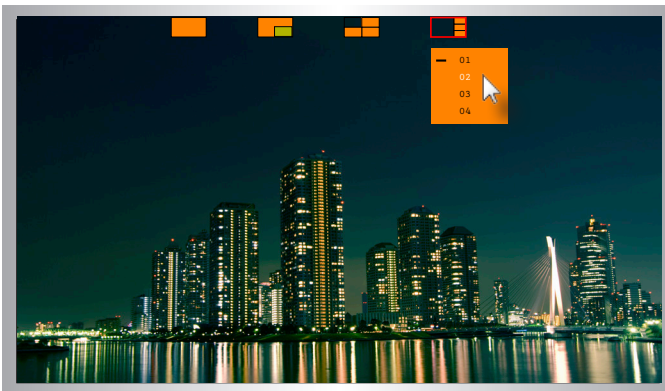

- The currently selected source for the *main* window will be indicated by a “dash”, as shown.

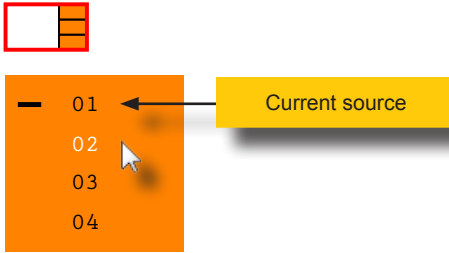

- Left click the desired input (1 - 4) from the drop-down menu.
- The selected source will also be displayed on both **Video B** and in the associated window in **Video A**.
- Click the middle mouse button / wheel to dismiss the Display Mode menu.

► Keyboard

- Press the following keys, in sequence, on the computer keyboard:

The default hotkey is the Scroll Lock key. To reassign the hotkey refer to [Defining the Hotkey \(page 40\)](#) for more information.

hotkey + **hotkey** + **A** + **X**

Where **X** is a number on the keyboard from 1 to 4. This number represents the source to be selected.

When a source is selected, it will appear on both **Video B** and in the *main* window of **Video A**.

For example, to switch to PAP mode and display the source connected to **Source 2**, in the *main* window, use the following keystrokes:

hotkey + **hotkey** + **A** + **2**

- The current source occupying the *main* window will be moved to a *subordinate* window. See [Window Management in PAP Mode \(page 37\)](#) for details on how the switcher manages *main* and *subordinate* windows in PAP mode.

► OSD

1. Press the following keys, in sequence, on the computer keyboard.

The default hotkey is the Scroll Lock key. To reassign the hotkey refer to [Defining the Hotkey \(page 40\)](#) for more information.



2. The OSD will be displayed.

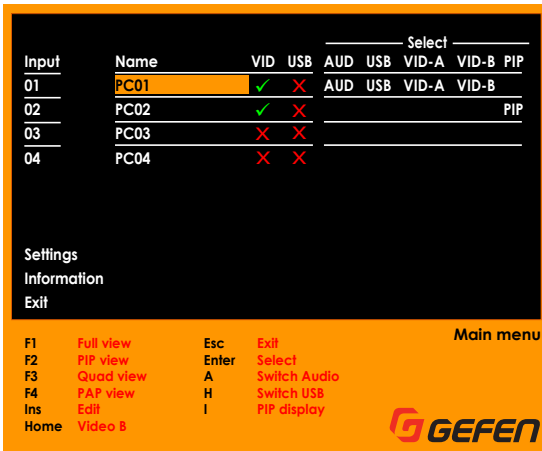

3. Press the **F4** key.
4. Press the **Esc** key to immediately exit the OSD.
5. Use the keyboard, mouse, or front panel buttons to set the source for the *main* window.
6. For more information about OSD features, refer to [OSD Menu \(page 39\)](#).

Information

The Solo USB and Audio buttons are used only to temporarily switch between devices. To unlink devices from one another, use the OSD, RS-232, or hotkeys. Refer to Linking / Unlinking USB (page 42), the #link and #unlink commands, and Hotkeys (page 117).

Independent USB Switching

By default, video, USB, and audio are switched simultaneously each time a different source is selected. However, the switcher provides you with the ability to independently route USB. This might be useful, for example, if you want to maintain the video connection to **Source 1** but temporarily switch USB control to **Source 3**.

1. Press the **USB** button on the front panel.
2. The USB button will glow solid blue. The switcher is now in *solo USB mode*. This will allow us to switch USB independently of video and audio.

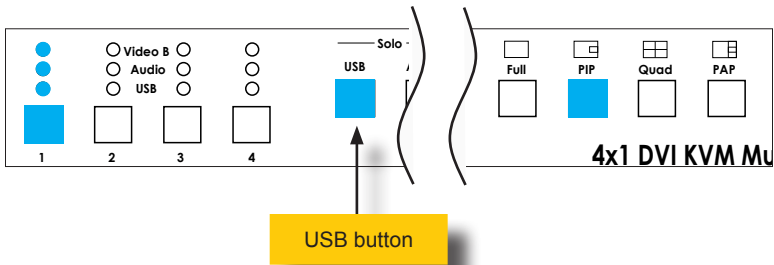

3. Press a source selection button (1 - 4) on the front panel to switch to the desired USB source.

In the example, below, we have switched to **Source 3**. Now, both video and audio are coming from **Source 1** but USB control is on **Source 3**.

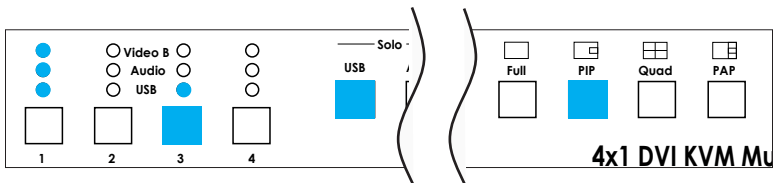

- To exit solo USB mode, press the **USB** button again.
- The **USB** button will turn off and the USB device will re-link with the currently selected **Video B** source.

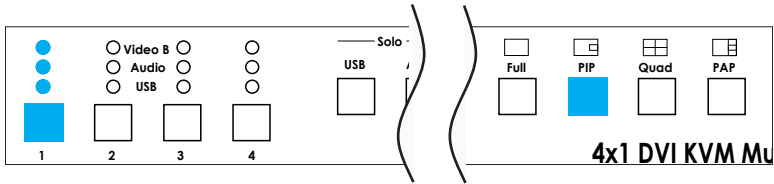

Independent Audio Switching

By default, video, USB, and audio are switched simultaneously each time a different source is selected. However, the 4x1 DVI KVM Multiview Switcher provides you with the ability to independently route audio. This might be useful, for example, if you want to maintain the video and USB connection to **Source 2** but temporarily use the audio from **Source 3**.

- Press the **Audio** button on the front panel.
- The **Audio** button will glow solid blue. The switcher is now in *solo audio mode*. This will allow us to switch audio independently of video and USB.

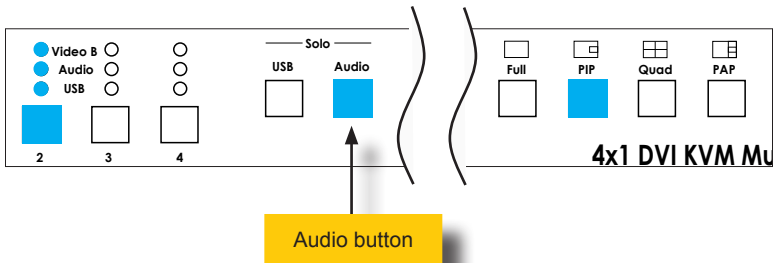

- Press a **Source** button (1 - 4) on the front panel to switch to the desired audio source.

In the example, below, we have switched the audio to **Source 3**. Now, both video and USB are coming from **Source 2** but the audio is coming from **Source 3**.

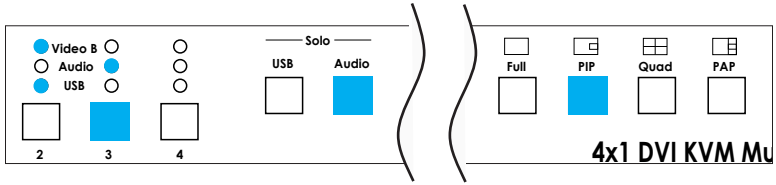

4. To exit solo audio mode, press the **Audio** button again.
5. The **Audio** button will turn off and the audio device will re-link with the currently selected **Video B** source.

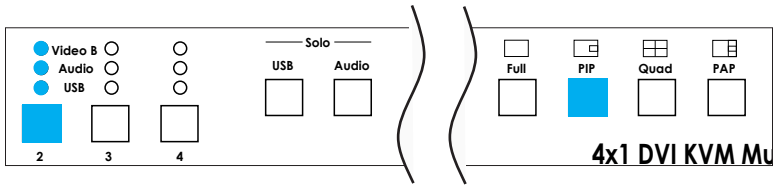

This section discusses some functions that are unique to PIP (Picture-In-Picture) and PAP (Picture-And-Picture) modes.

Zoom and Position (PIP Only)

1. Enter PIP mode and set the *main* and *subordinate* windows with the desired sources.
2. Click the middle mouse button / wheel to display the Mode menu.



3. Place the mouse cursor over the subordinate window.
4. Left-click and drag the window to the desired position on the screen.

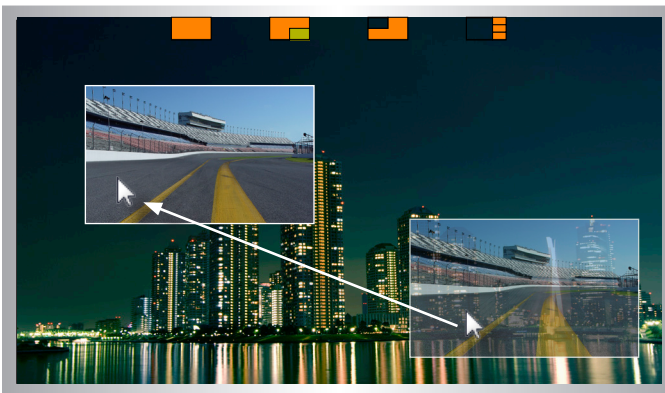

- 5. To zoom-in or zoom-out of the subordinate window, use the scroll wheel on the mouse. Make sure that the mouse cursor is placed over the subordinate window before zooming.

Note that the zoom-in and zoom-out direction (scroll up or scroll down) will depend upon the scroll settings of the mouse.

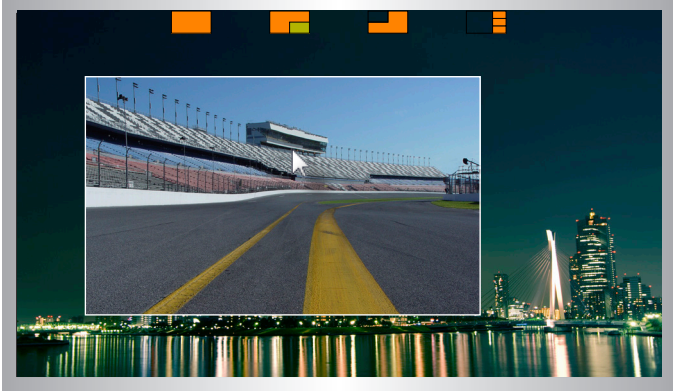

- 6. Once the subordinate window is set to the desired position and size, click the scroll button to dismiss the Mode menu.

Window Management in PAP Mode

In PAP mode, the 4x1 DVI KVM Multiview Switcher manages *subordinate* windows by switching the *main* window with a *subordinate* window when a different source is selected. The following example illustrates that moving a *subordinate* window to the *main* window is not arbitrary.

- 1. Given that the *main* window is **Source 1**:

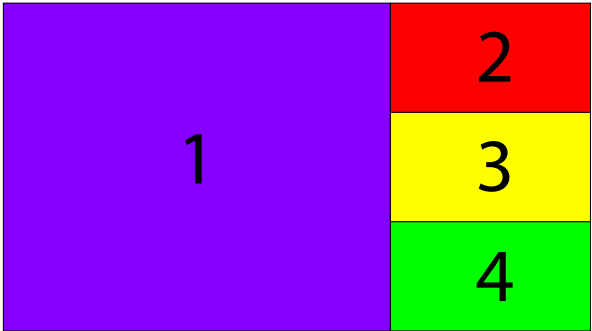

2. Pressing the **Source 2** button swaps window 1 with window 2:

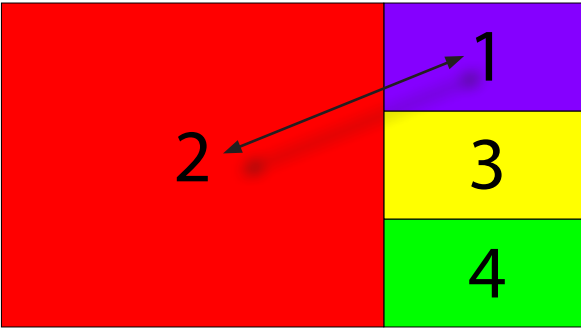

3. Pressing the **Source 4** button swaps window 2 with window 4:

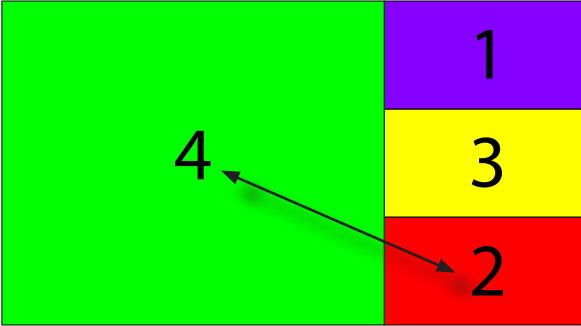

4. Finally, if we wanted Source 1 back in the main window, we would press the **Source 1** button, which would swap window 4 with window 1.

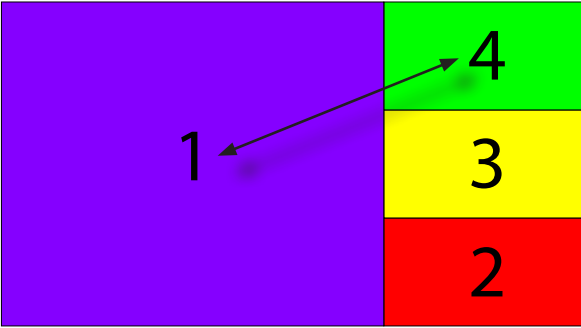

Accessing the Menu System

The 4x1 DVI KVM Multiview Switcher uses a built-in menu system to manage and control all video features.

1. Access the menu system using the following keystrokes:

The default hotkey is the Scroll Lock key. To reassign the hotkey refer to [Defining the Hotkey \(page 40\)](#) for more information.



2. The menu system will be displayed in the foreground.

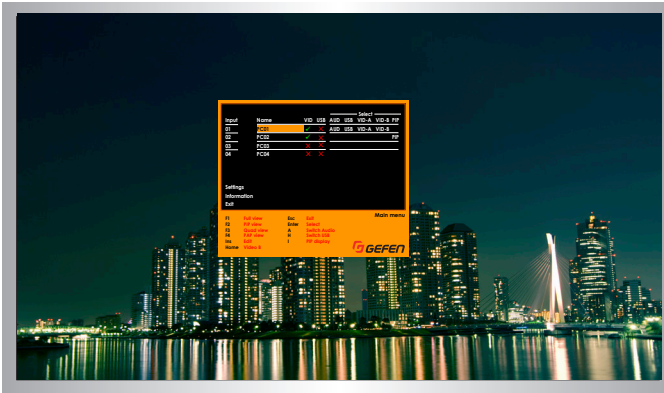

3. To dismiss the menu system, press the *Esc* key.
4. See the following pages for information on using the various functions within the OSD.

Defining the Hotkey

The default hotkey is the Scroll Lock key. However, the hotkey assignment can be changed. The Scroll Lock key is used in the following procedure.

- To access the menu system, use the following keystrokes:

Scroll Lock + **Scroll Lock** + **Space Bar**

- Select the **Settings** option using the ▲ or ▼ keys on the computer keyboard.

Input	Name	VID	USB	Select				
				AUD	USB	VID-A	VID-B	PIP
01	PC01		✗	AUD	USB	VID-A	VID-B	PIP
02	PC02	✓	✗					
03	PC03	✗	✗					
04	PC04	✗	✗					

Settings

Information
Exit

F1 Full view Esc Exit
F2 PIP view Enter Select
F3 Quad view A Switch Audio
F4 PAP view H Switch USB
Ins Edit I PIP display
Home Video B

Main menu

GEFEN

- Press the **Enter** key.

Hotkey	Scroll		
Link USB	Yes		
Link Audio	Yes		
Link Video B	Yes		
OSD Timeout	30		Sec
Titlebar Timeout	05		Sec
Show PC Name	Yes		
Show Video Signal	Yes		

Next Page

Main Menu
Information
Exit

F1 Full view Esc Exit
F2 PIP view Enter Select
F3 Quad view + + Navigate
F4 PAP view + + Change

Settings

GEFEN

4. Select the desired hotkey using the ◀ or ▶ keys on the computer keyboard.

The available selections are: **Scroll**, **Caps**, **NumLock**, **L Ctrl**, or **R Ctrl**.

5. Once the desired hotkey has been selected, press the Esc key.
6. The following message will be displayed:



7. Press the Enter key to select the Yes option and save the changes.
To discard changes, press the ▶ key to select the No option, then press Enter.
8. To return to the previous screen, without making changes, press the Esc key.

Linking / Unlinking USB

1. Enter the menu system. See [Accessing the Menu System \(page 39\)](#) for more information.
2. Select the **Settings** option using the ▲ or ▼ keys on the computer keyboard.

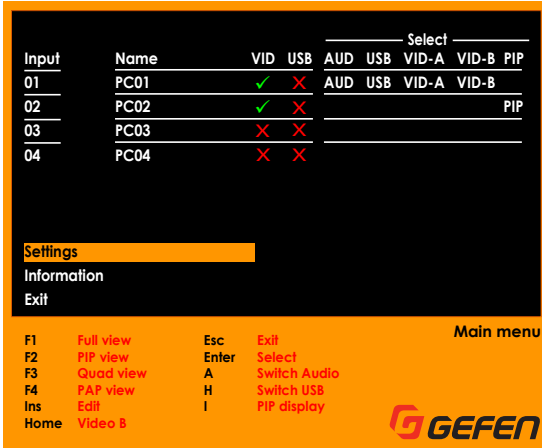

3. Press the **Enter** key.
4. Use the ▲ or ▼ keys to select the **Link USB** option.

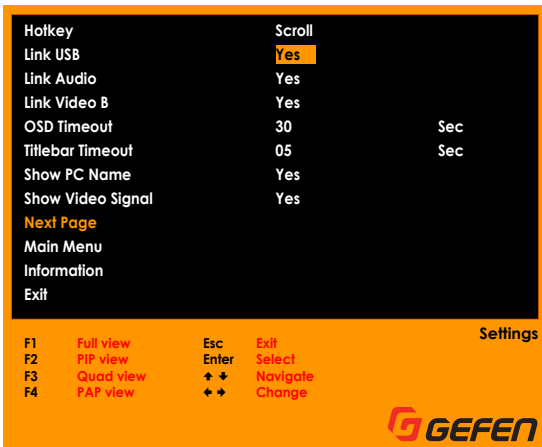

5. Select the desired option by using the ◀ or ▶ keys.

If the **Link USB** is set to **Yes**, then the USB will follow the source when switching.

If the **Link USB** is set to **No**, then the USB can be routed independently of the currently selected source.

6. Once the desired option has been selected, press the **Esc** key.
7. The following message will be displayed:



8. Press the **Enter** key to select the **Yes** option and save the changes.
To discard changes, press the ▶ key to select the **No** option, then press **Enter**.
9. To return to the previous screen, without making changes, press the **Esc** key.

Linking / Unlinking Audio

1. Enter the menu system. See [Accessing the Menu System \(page 39\)](#) for more information.
2. Select the **Settings** option using the ▲ or ▼ keys on the computer keyboard.

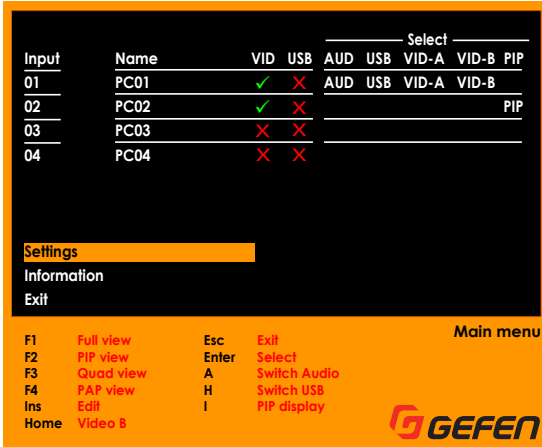

3. Press the **Enter** key.
4. Use the ▲ or ▼ keys to select the **Link Audio** option.

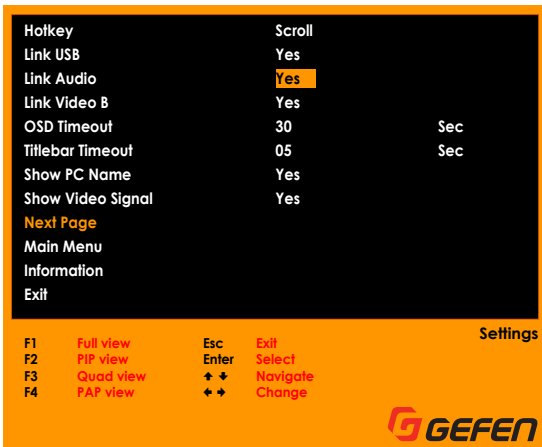

5. Select the desired option by using the ◀ or ▶ keys.

If the **Link Audio** is set to **Yes**, then the Audio will follow the source when switching.

If the **Link Audio** is set to **No**, then the Audio can be routed independently of the currently selected source.

6. Once the desired option has been selected, press the **Esc** key.
7. The following message will be displayed:



8. Press the **Enter** key to select the **Yes** option and save the changes.
To discard changes, press the ▶ key to select the **No** option, then press **Enter**.
9. To return to the previous screen, without making changes, press the **Esc** key.

Linking / Unlinking Video B

1. Enter the menu system. See [Accessing the Menu System \(page 39\)](#) for more information.
2. Select the **Settings** option using the ▲ or ▼ keys on the computer keyboard.

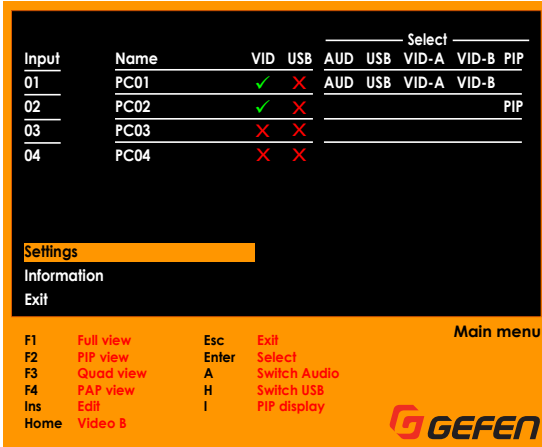

3. Press the **Enter** key.
4. Use the ▲ or ▼ keys to select the **Link Video B** option.

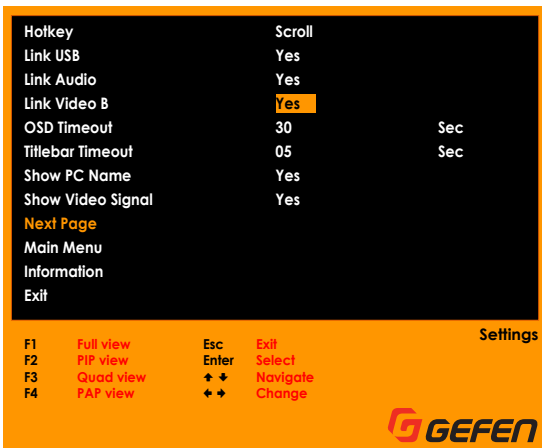

5. Select the desired option by using the ◀ or ▶ keys.

If the **Link Video B** is set to **Yes**, then the display connected to **Video B** will always show the currently selected source. This is the default setting.

If the **Link Video B** is set to **No**, then this will allow each display (**Video A** and **Video B**) to show a different source.

6. Once the desired option has been selected, press the **Esc** key.
7. The following message will be displayed:



8. Press the **Enter** key to select the **Yes** option and save the changes.
To discard changes, press the ▶ key to select the **No** option, then press **Enter**.
9. To return to the previous screen, without making changes, press the **Esc** key.

OSD Timeout

1. Enter the menu system. See [Accessing the Menu System \(page 39\)](#) for more information.
2. Select the **Settings** option using the ▲ or ▼ keys on the computer keyboard.

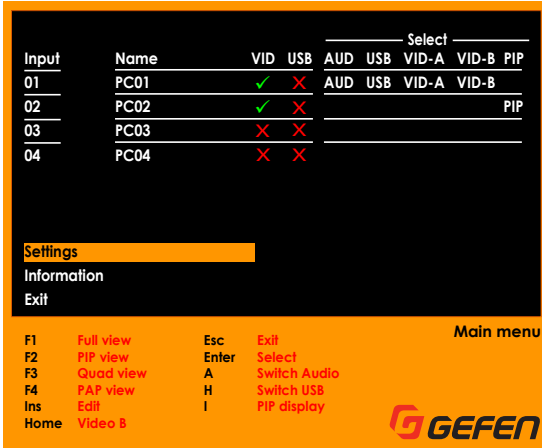

3. Press the **Enter** key.
4. Use the ▲ or ▼ keys to select the **OSD Timeout** option.

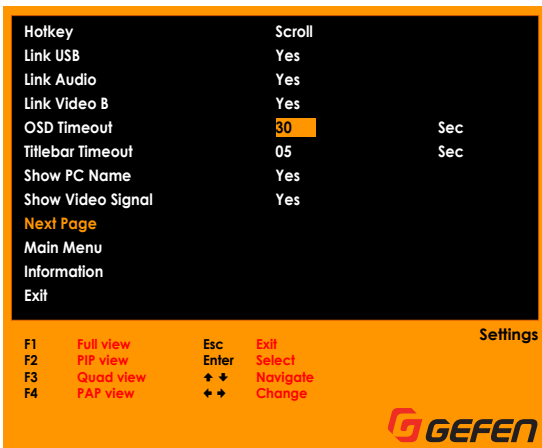

5. Select the desired timeout by using the ◀ or ▶ keys.

The timeout can be set to one of the following values, in seconds: **0, 5, 10, 15, 20, 25, 30, 40, 50, or 60**. To keep the OSD displayed at all times, set the **OSD Timeout** value to 0 seconds. The default value is 10 seconds.

6. Once the desired option has been selected, press the **Esc** key.
7. The following message will be displayed:



8. Press the **Enter** key to select the **Yes** option and save the changes.
To discard changes, press the ▶ key to select the **No** option, then press **Enter**.
9. To return to the previous screen, without making changes, press the **Esc** key.

Titlebar Timeout

1. Enter the menu system. See [Accessing the Menu System \(page 39\)](#) for more information.
2. Select the **Settings** option using the ▲ or ▼ keys on the computer keyboard.

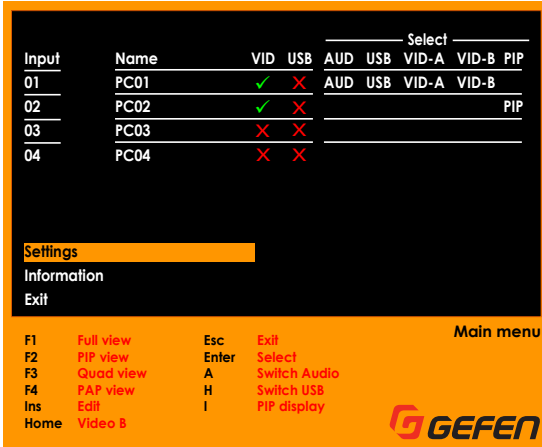

3. Press the **Enter** key.
4. Use the ▲ or ▼ keys to select the **Titlebar Timeout** option.

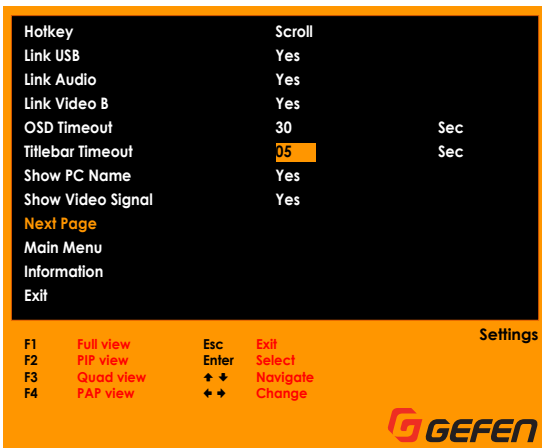

5. Select the desired timeout by using the ◀ or ▶ keys.

The timeout can be set to one of the following values, in seconds: **0, 5, 10, 15, 20, 25, 30, or OFF**. To keep the titlebar displayed at all times, set the **Titlebar Timeout** value to 0 seconds. To prevent the titlebar from being displayed, set the timeout value to **OFF**. The default value is 5 seconds.

6. Once the desired option has been selected, press the **Esc** key.
7. The following message will be displayed:



8. Press the **Enter** key to select the **Yes** option and save the changes.
To discard changes, press the ▶ key to select the **No** option, then press **Enter**.
9. To return to the previous screen, without making changes, press the **Esc** key.

Show PC Name

1. Enter the menu system. See [Accessing the Menu System \(page 39\)](#) for more information.
2. Select the **Settings** option using the ▲ or ▼ keys on the computer keyboard.

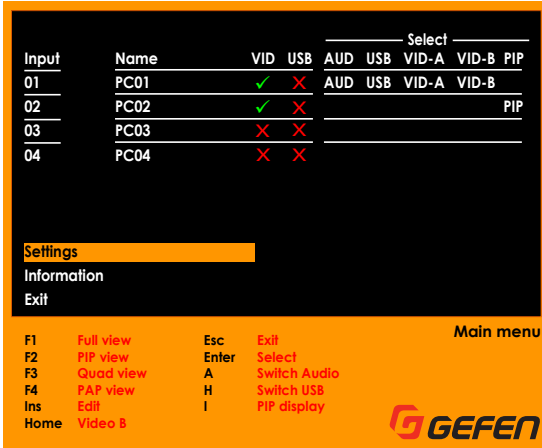

3. Press the **Enter** key.
4. Use the ▲ or ▼ keys to select the **Show PC Name** option.

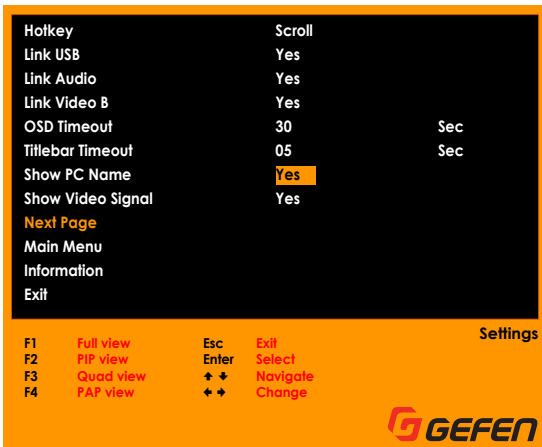

4. Select the desired option by using the ◀ or ▶ keys.

If the **Show PC Name** is set to **Yes**, then the name of the PC will be displayed above the current input resolution. This is the default setting.

If the **Show PC Name** is set to **No**, then only the input resolution will be displayed.

See [Show Video Signal \(page 54\)](#) for more information on hiding / displaying the current input resolution.

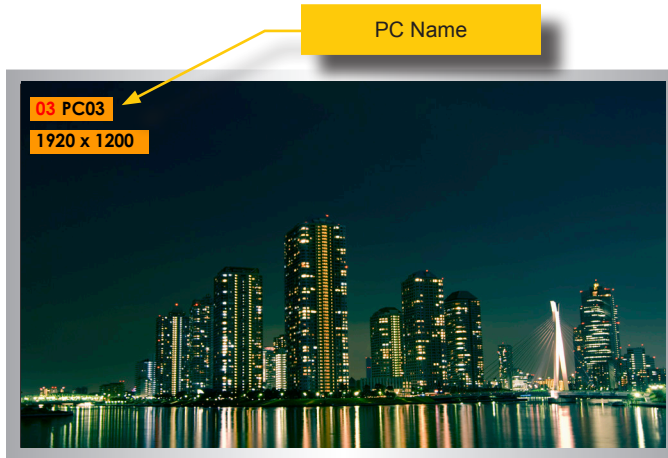

5. Once the desired option has been selected, press the **Esc** key.
6. The following message will be displayed:



7. Press the **Enter** key to select the **Yes** option and save the changes.
To discard changes, press the ▶ key to select the **No** option, then press **Enter**.
8. To return to the previous screen, without making changes, press the **Esc** key.

Show Video Signal

1. Enter the menu system. See [Accessing the Menu System \(page 39\)](#) for more information.
2. Select the **Settings** option using the ▲ or ▼ keys on the computer keyboard.

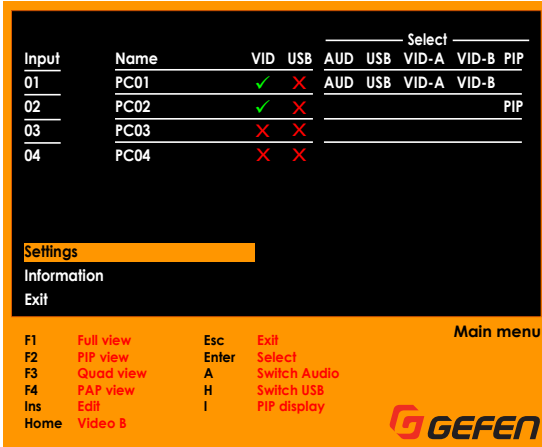

3. Press the **Enter** key.
4. Use the ▲ or ▼ keys to select the **Show Video Signal** option.



5. Select the desired option by using the ◀ or ▶ keys.

If the **Show Video Signal** is set to **Yes**, then the current input resolution will be displayed below the current PC name. This is the default setting.

If the **Show Video Signal** is set to **No**, then only the PC name will be displayed.

See [Show PC Name \(page 52\)](#) for more information on hiding / displaying the PC name.

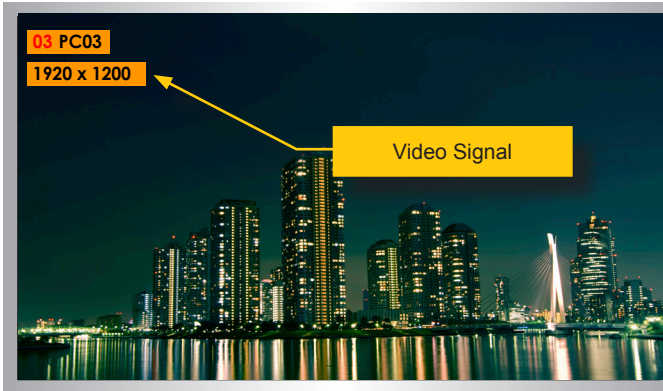

6. Once the desired option has been selected, press the **Esc** key.
7. The following message will be displayed:



8. Press the **Enter** key to select the **Yes** option and save the changes.
To discard changes, press the ▶ key to select the **No** option, then press **Enter**.
9. To return to the previous screen, without making changes, press the **Esc** key.

Output Resolution

1. Enter the menu system. See [Accessing the Menu System \(page 39\)](#) for more information.
2. Select the **Settings** option using the ▲ or ▼ keys on the computer keyboard.

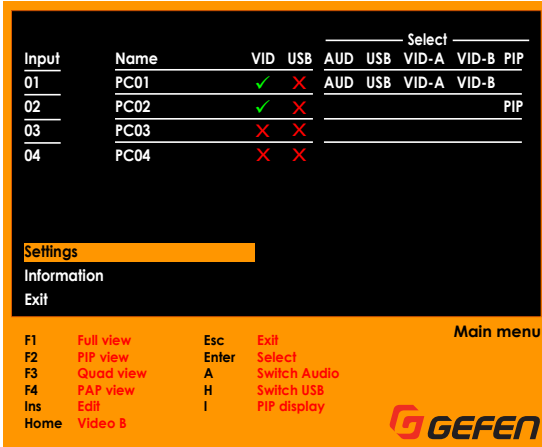

3. Press the **Enter** key.
4. Use the ▲ or ▼ keys to select the **Next Page** option.

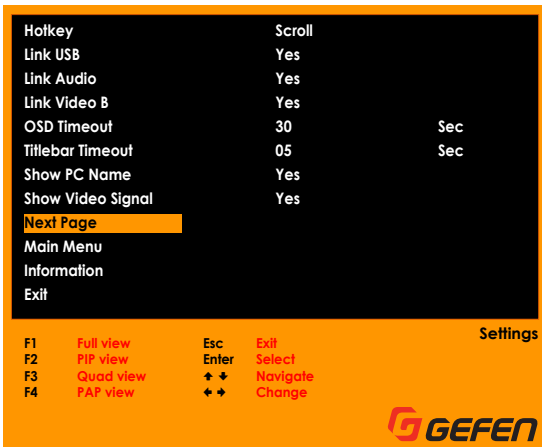

5. Press the **Enter** key.

- Use the ▲ or ▼ keys to select the **Output Resolution** option.

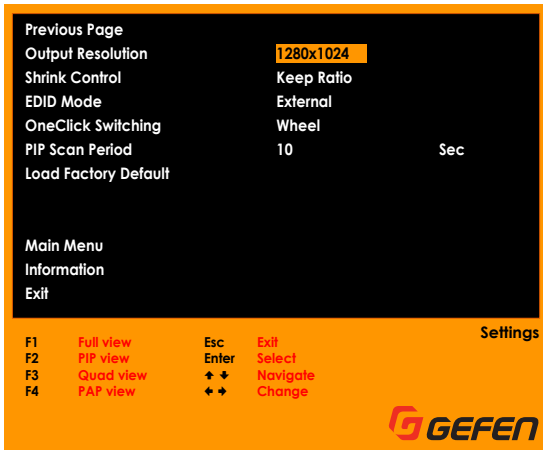

Important

Before changing this setting, make sure that the connected display can support the selected output resolution. If an unsupported resolution is selected, you will need to set the output resolution using the RS-232 command set. See the `#set_output` command for more information.

- Select the desired resolution by using the ◀ or ▶ keys.

The following resolutions are available: **1024x768**, **1280x1024**, **1280x720**, **1360x768**, **1600x1200**, **1680x1050**, **1920x1080**, **1920x1200**, and **Auto**.

- Once the desired resolution has been selected, press the **Esc** key.
- The following message will be displayed:



- Press the **Enter** key to select the **Yes** option and save the changes.
To discard changes, press the ▶ key to select the **No** option, then press **Enter**.
- To return to the previous screen, without making changes, press the **Esc** key.

Shrink Control

1. Enter the menu system. See [Accessing the Menu System \(page 39\)](#) for more information.
2. Select the **Settings** option using the ▲ or ▼ keys on the computer keyboard.

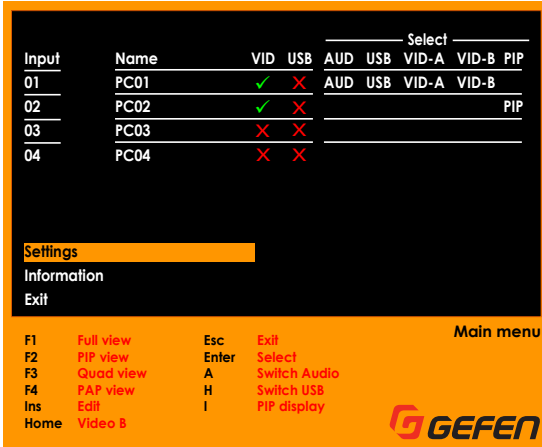

3. Press the **Enter** key.
4. Use the ▲ or ▼ keys to select the **Next Page** option.

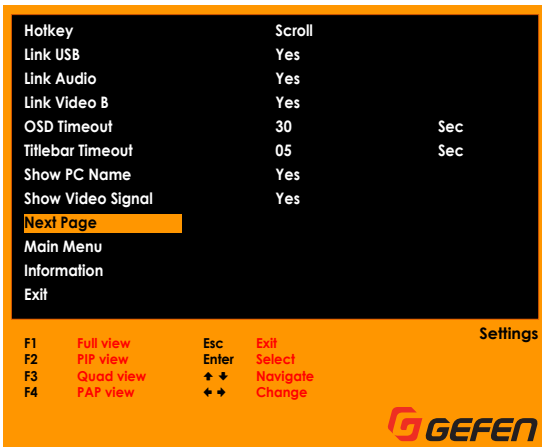

5. Press the **Enter** key.

6. Use the ▲ or ▼ keys to select the **Shrink Control** option.

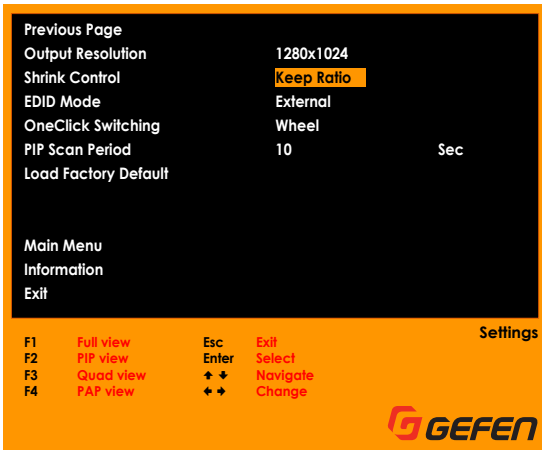

7. Select the desired option by using the ◀ or ▶ keys.

If the **Shrink Control** is set to **Keep Ratio**, then the output aspect ratio will match the input aspect ratio. This is the default setting.

If the **Shrink Control** is set to **Fill**, then the image will be stretched to fill the screen.

8. Once the desired resolution has been selected, press the **Esc** key.
9. The following message will be displayed:



10. Press the **Enter** key to select the **Yes** option and save the changes.
- To discard changes, press the ▶ key to select the **No** option, then press **Enter**.
11. To return to the previous screen, without making changes, press the **Esc** key.

EDID Mode

1. Enter the menu system. See [Accessing the Menu System \(page 39\)](#) for more information.
2. Select the **Settings** option using the ▲ or ▼ keys on the computer keyboard.

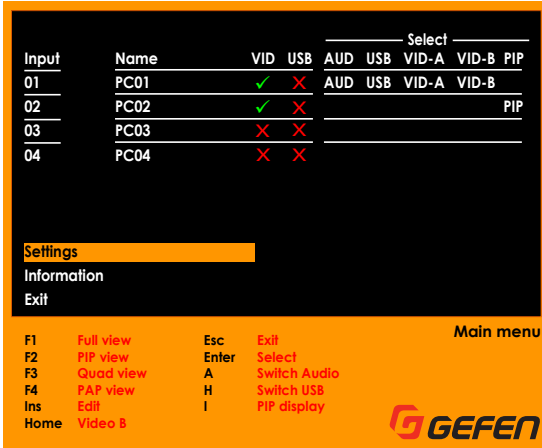

3. Press the **Enter** key.
4. Use the ▲ or ▼ keys to select the **Next Page** option.

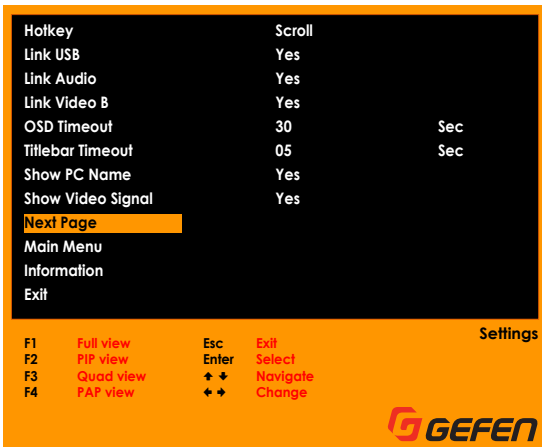

5. Press the **Enter** key.

6. Use the ▲ or ▼ keys to select the **EDID Control** option.

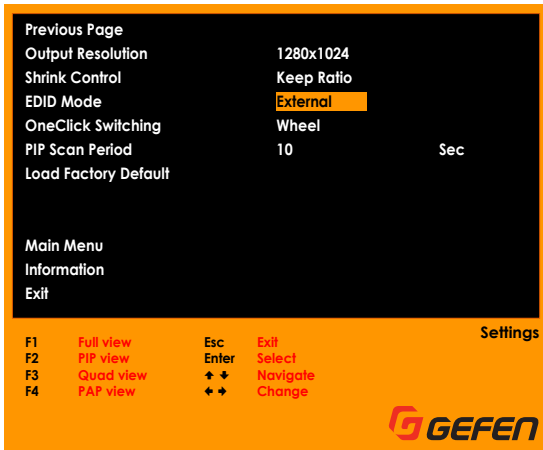

7. Select the desired option by using the ◀ or ▶ keys.

If the **EDID Mode** is set to **External**, then EDID from the display that is connected to Video A will be used. This is the default setting.

If the **EDID Mode** is set to **1080P**, then the display connected to Video A will use the built-in internal EDID.

8. Once the desired option has been selected, press the **Esc** key.
9. The following message will be displayed:



10. Press the **Enter** key to select the **Yes** option and save the changes.
- To discard changes, press the ▶ key to select the **No** option, then press **Enter**.
11. To return to the previous screen, without making changes, press the **Esc** key.

One-Click Switching

1. Enter the menu system. See [Accessing the Menu System \(page 39\)](#) for more information.
2. Select the **Settings** option using the ▲ or ▼ keys on the computer keyboard.

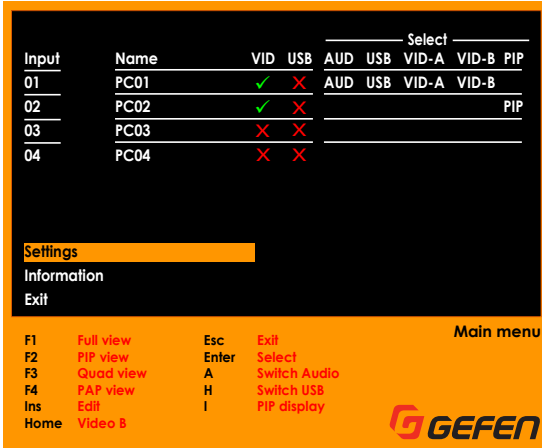

3. Press the **Enter** key.
4. Use the ▲ or ▼ keys to select the **Next Page** option.

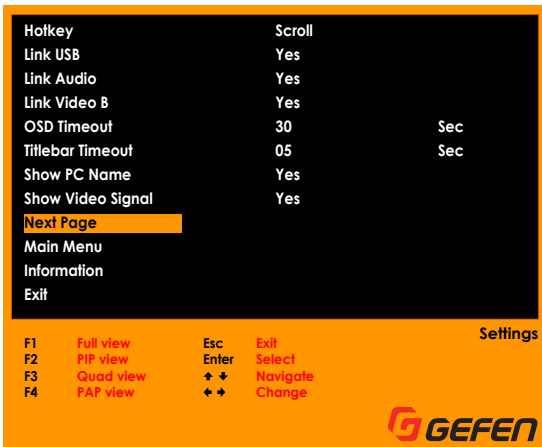

5. Press the **Enter** key.

6. Use the ▲ or ▼ keys to select the **One-Click Switching** option.

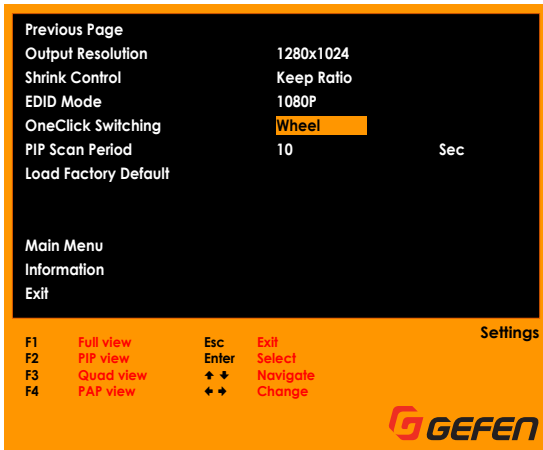

7. Select the desired option by using the ◀ or ▶ keys.

The following options are available: **Wheel**, **Button 4**, **Button 5**, or **Disabled**. The default setting is **Wheel**.

8. Once the desired option has been selected, press the **Esc** key.
9. The following message will be displayed:



10. Press the **Enter** key to select the **Yes** option and save the changes.

To discard changes, press the ▶ key to select the **No** option, then press **Enter**.

11. To return to the previous screen, without making changes, press the **Esc** key.

PIP Scan Period

1. Enter the menu system. See [Accessing the Menu System \(page 39\)](#) for more information.
2. Select the **Settings** option using the ▲ or ▼ keys on the computer keyboard.

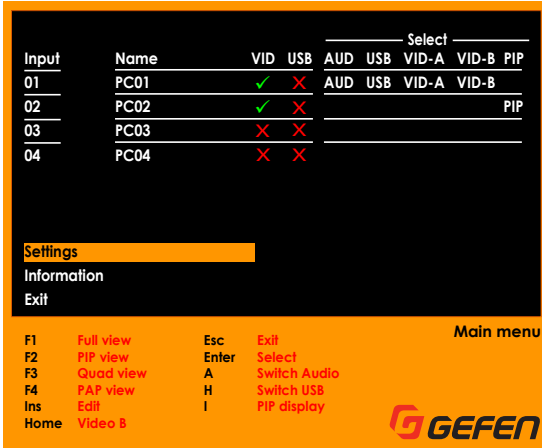

3. Press the **Enter** key.
4. Use the ▲ or ▼ keys to select the **Next Page** option.

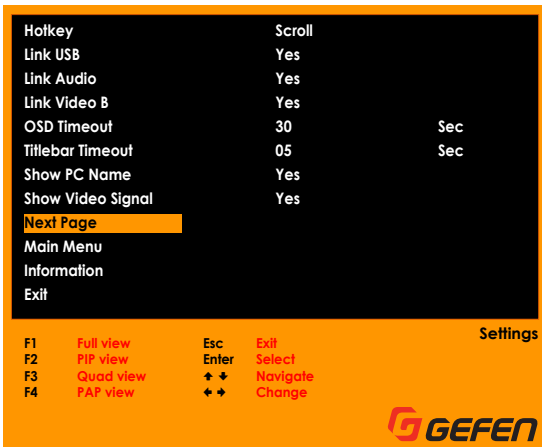

5. Press the **Enter** key.

- Use the ▲ or ▼ keys to select the **PIP Scan Period** option.

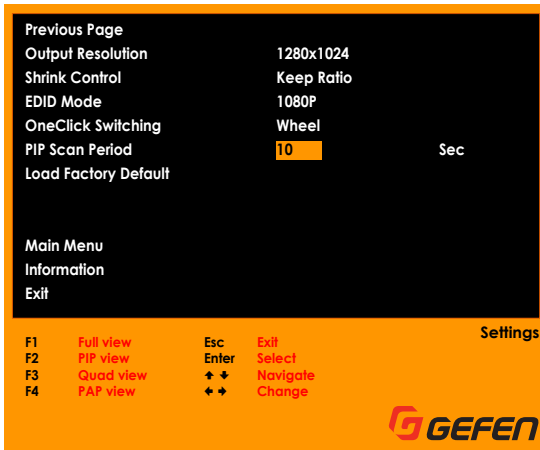

- Select the desired option by using the ◀ or ▶ keys.

The following time periods (in seconds) are available: **10, 20 30, 40, 50, or 60**.
The default setting is **10**.

- Once the desired option has been selected, press the **Esc** key.
- The following message will be displayed:



- Press the **Enter** key to select the **Yes** option and save the changes.
To discard changes, press the ▶ key to select the **No** option, then press **Enter**.
- To return to the previous screen, without making changes, press the **Esc** key.

Load Factory Default

1. Enter the menu system. See [Accessing the Menu System \(page 39\)](#) for more information.
2. Select the **Settings** option using the ▲ or ▼ keys on the computer keyboard.

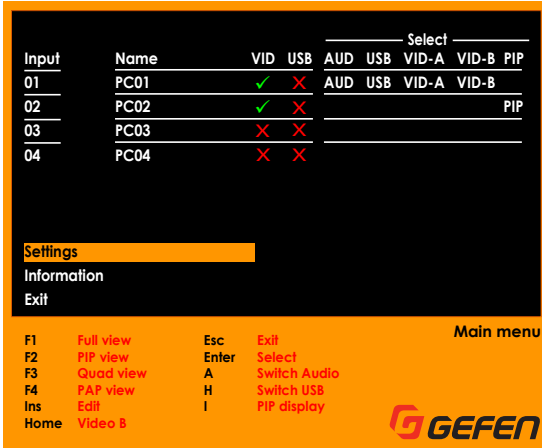

3. Press the **Enter** key.
4. Use the ▲ or ▼ keys to select the **Next Page** option.

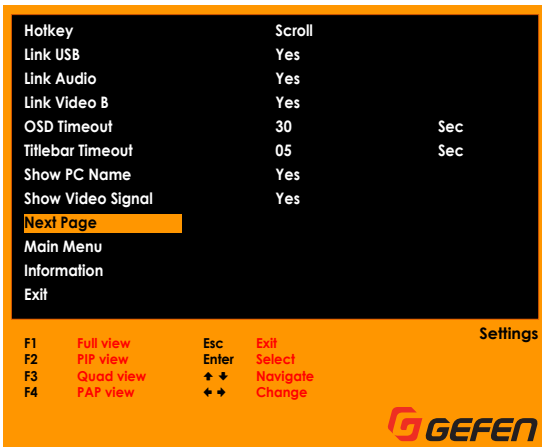

5. Press the **Enter** key.

6. Use the ▲ or ▼ keys to select the **Load Factory Default** option.

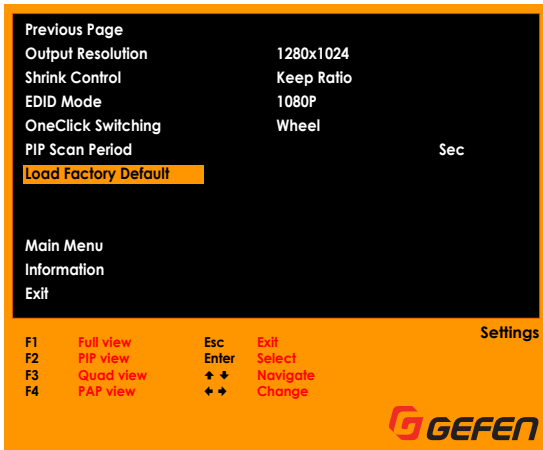

7. Press the **Enter** key.
8. The following message will be displayed:

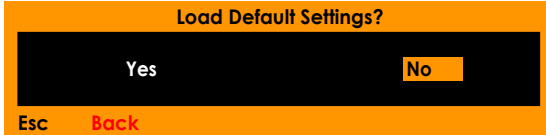

The **No** option will be selected by default.

- ▶ To continue *without* resetting the unit to factory-default settings, press the **Enter** key.
 - ▶ To reset the unit to factory-default settings, select the **Yes** option using the ◀ or ▶ key and then press the **Enter** key.
9. To return to the previous screen, without making changes, press the **Esc** key.

Read Monitor EDID

The Read Monitor EDID function is designed to be used if the 4x1 DVI KVM Multiview Switcher is unable to automatically read the EDID of the display connected to **Video A**. If the display's EDID is corrupted, then the switcher will automatically use the built-in EDID on the switcher.

1. Enter the menu system. See [Accessing the Menu System \(page 39\)](#) for more information.
2. Make sure the **EDID Mode** is set to **External**.
3. Select the **Information** option using the ▲ or ▼ keys on the computer keyboard.

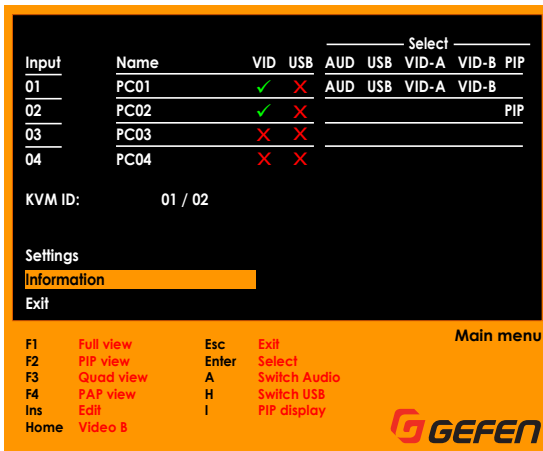

4. Press the **Enter** key to display the **Information** screen.

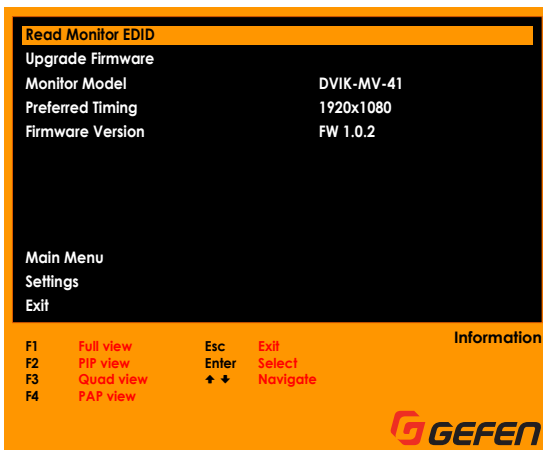

5. The Read Monitor EDID option will be highlighted.
6. Press the **Enter** key to read the EDID.
7. The following progress bar will be displayed as the 4x1 DVI KVM Multiview Switcher reads the EDID of the display that is connected to Video A:



8. After the progress bar disappears, the EDID-reading process will be complete.
9. The EDID of the display connected to Video A will now be used.

Upgrade Firmware

1. Enter the menu system. See [Accessing the Menu System \(page 39\)](#) for more information.
2. Select the **Information** option using the ▲ or ▼ keys on the computer keyboard.

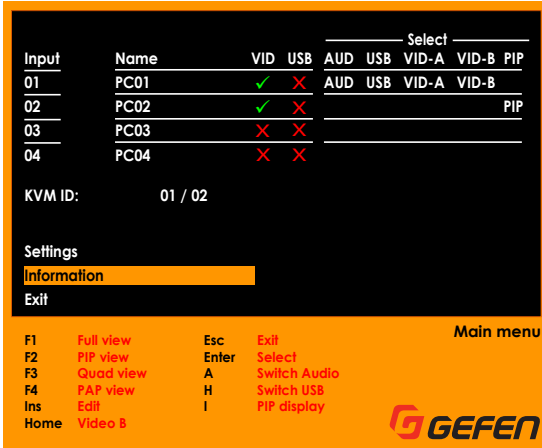

3. On the following screen, select **Upgrade Firmware** using the ▲ or ▼ keys on the computer keyboard.

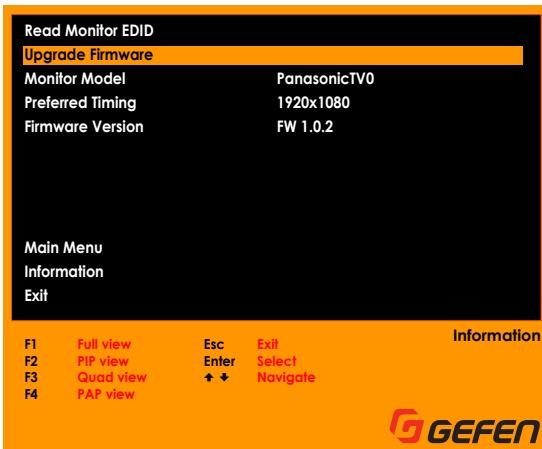

4. Press the **Enter** button to begin the upgrade process.
5. Refer to [Firmware Upgrade \(page 119\)](#) for instructions on completing the process.

Changing the Source Name

By default, each of the four inputs on the switcher is named as follows: PC01, PC02, PC03, and PC04. To keep track of your sources, it is recommended to use names that are unique to each device.

1. Enter the menu system. See [Accessing the Menu System \(page 39\)](#) for more information.
2. Select the desired **Input Name** by using the ▲ or ▼ keys on the computer keyboard.
3. Press the **Ins** key.
4. The **Input Name** text will be red and the first character in the **Input Name** will be highlighted in blue.

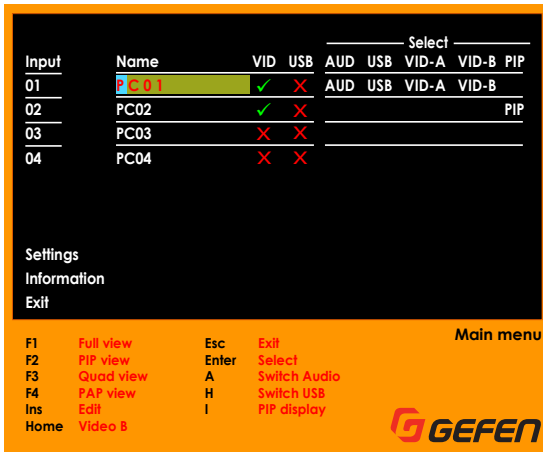

5. Type the new name of the **Input Name**. The name cannot exceed 12 characters in length.
6. Press the **Enter** key.

7. The new Input Name will be displayed.

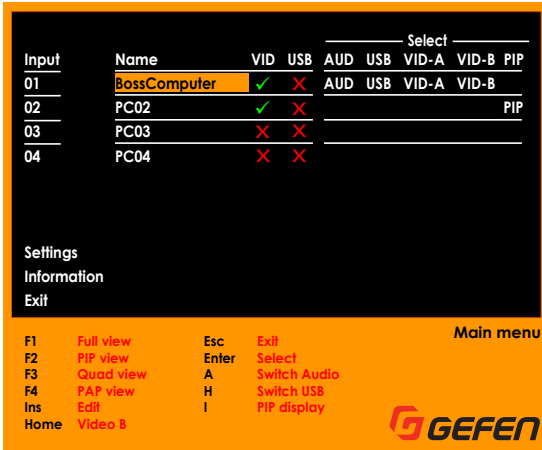

8. Repeat steps 2 - 6 for each input, as desired.

4x1 DVI KVM Multiview Switcher

3

Advanced Operation

By cascading (“daisy-chaining”) switchers, up to 32 computers can be controlled from a single keyboard and mouse. The **RS-232 In / RS-232 Out** ports are used to connect each switch in the chain. A maximum of eight switchers can be connected.

i Information

The video, audio, and front-panel USB devices *cannot* be shared (connected) between switchers. An external RS-232 controller connected to switcher #1 can send commands to all of the connected switchers, if needed.

1. Connect an RS-232 controller (if applicable) to the **RS-232 In** port on the first switcher.
2. Connect another RS-232 cable to the **RS-232 Out** port.
3. Connect the opposite end of the RS-232 cable, from the first switcher, to the **RS-232 In** port on the second switcher.
4. Continue the process outlined in steps 2 and 3 for each switcher.
5. The connection of each switcher should appear as follows:

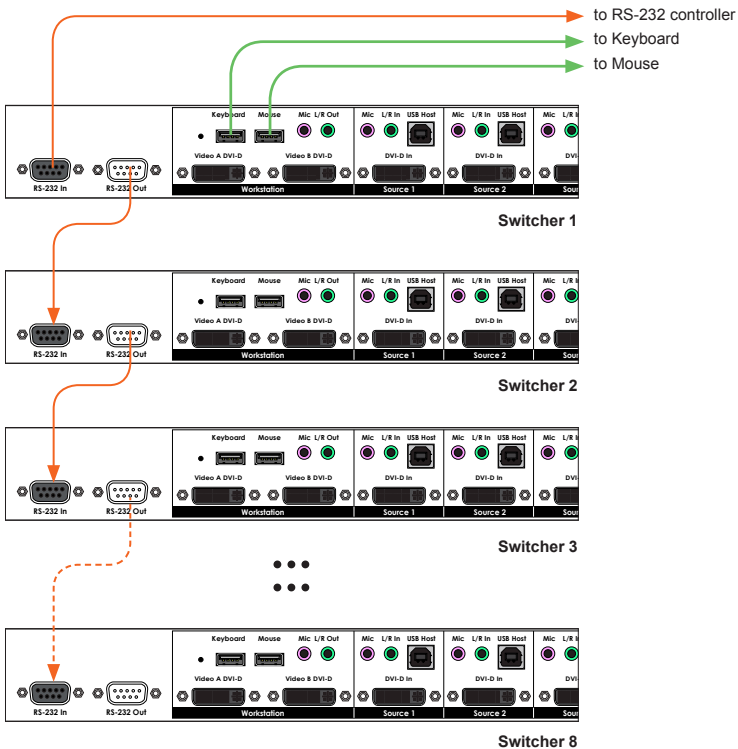

6. Here is a sample wiring diagram of three switchers connected together using two RS-232 cables.

The first switcher in the chain has an ID of 1. The second switcher in the chain is 2, the third switcher is 3, and so on.

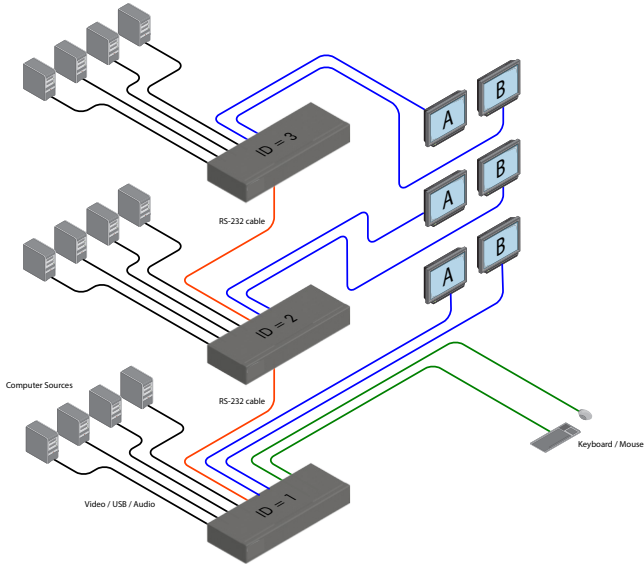

7. Display the OSD using the keyboard or front-panel buttons.

Input	Name	VID	USB	Select				
				AUD	USB	VID-A	VID-B	PIP
01	PC01	✓	✗	AUD	USB	VID-A	VID-B	PIP
02	PC02	✓	✗					PIP
03	PC03	✗	✗					
04	PC04	✗	✗					

KVM ID: 01 / 03

Settings
Information
Exit

F1 Full view Esc Exit
F2 PIP view Enter Select
F3 Quad view A Switch Audio
F4 PAP view H Switch USB
Ins Edit I PIP display
Home Video B

Main menu

GEFEN

8. Next to **KVM ID**, there are two numbers. The first number is the active switcher. The second number is the total number of switchers in the chain.

In the example below, we have **01 / 03**:

Input	Name	VID	USB	Select				
				AUD	USB	VID-A	VID-B	PIP
01	PC01	✓	✗	AUD	USB	VID-A	VID-B	PIP
02	PC02	✓	✗					
03	PC03	✗	✗					
04	PC04	✗	✗					

KVM ID: 01 / 03

Settings
Information
Exit

F1 Full view Esc Exit
F2 PIP view Enter Select
F3 Quad view A Switch Audio
F4 PAP view H Switch USB
Ins Edit I PIP display
Home Video B

Main menu

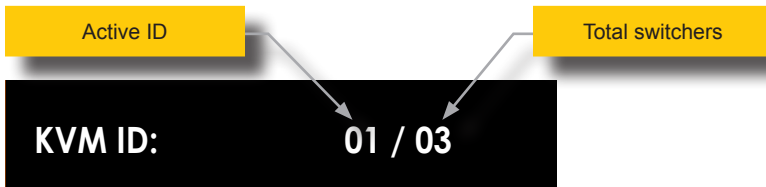
Because all the switchers are connected, we can control any of switches directly from the keyboard and mouse that are connected to the first switcher in the chain.

9. To move between switchers, use one of the following methods:
- Use the `#kvm` command to set the active switcher.
 - Use the following hotkey combination:

hotkey + *hotkey* + **K** + X

Where X is a number on the keyboard from 1 to 8. This number represents the switcher to be selected.

- Move the mouse cursor to the desired display of the switcher to be controlled.

10. For example, to switch to switcher 3 using hotkeys, type the following:

hotkey + **hotkey** + **K** + **3**

11. Display the OSD using the keyboard or front-panel buttons.

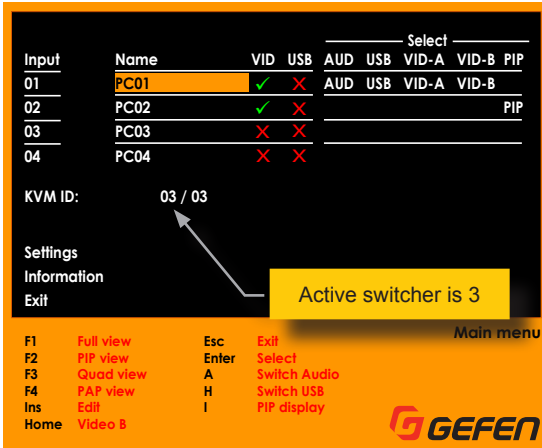

12. To set the active switcher using the mouse, make sure that the *display mode* icons are displayed in the active display.
13. Click the middle mouse button to bring up the *display mode* icons.

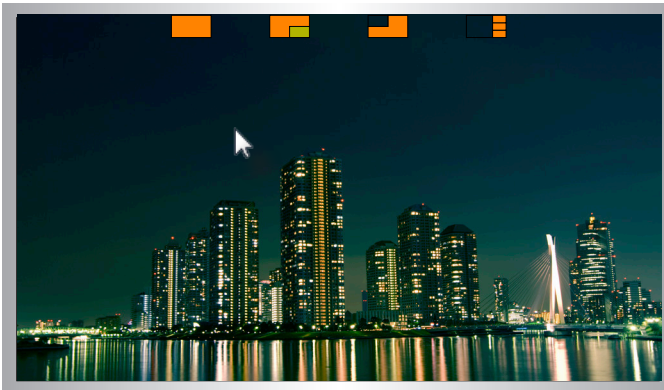

10. Move the mouse cursor to the display connected to switcher 2.

Note that in *display mode*, that the mouse is not displayed on Video B when moving between switchers.



Video A (Switcher 2)



Video A (Switcher 3)

11. As soon as the mouse is displayed on **Video A** on switcher 2, then switcher 2 will be the active switcher.
12. Select the desired display mode for **Video A** on switcher 2 by clicking the middle mouse button.

RS-232 Interface

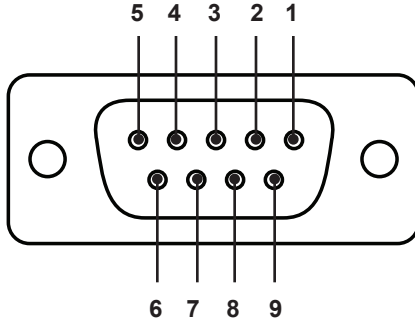

RS-232 Controller

Switcher

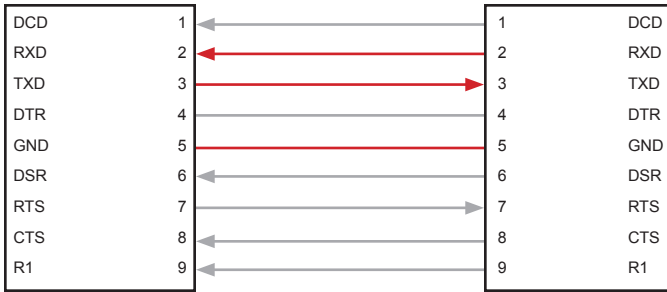

Only TXD, RXD, and GND pins are used.

RS-232 Settings

Description	Setting
Baud rate	115200
Data bits	8
Parity	None
Stop bits	1
Hardware flow control	None



Important

When sending RS=232 commands, a carriage return (0x0d) and a line feed (0x0a) must be included and the end of the command.

Command	Description
#aspect	Sets the aspect ratio
#audio	Switches the audio source
#beeper	Activates the beeper
#fadefault	Resets unit to factory-default settings
#help	Displays all available commands
#hotkey	Sets the hotkey
#kvm	Switches the active KVM
#link	Binds peripherals to the specified KVM port
#list	Displays the hotkey list
#lock_edid	Locks EDID settings during power-up
#mode	Sets the display mode
#mute	Mutes the audio
#pip	Sets the Picture-In-Picture mode
#quad	Sets Quad-View mode
#reboot	Reboots the unit
#scan	Auto-scan mode
#set_edid	Sets the EDID mode
#set_mask	Masks the video on the specified port
#set_output	Sets the output resolution
#show_edid	Displays the EDID settings
#show_output	Displays the current output resolution
#show_ver_data	Displays the software
#unlink	Unbind peripherals from the KVM port
#upgrade	Upgrade the firmware
#usb	Switches the USB port
#usbreset	Resets the USB
#video	Switches the video source
#video_b	Switches the auxiliary monitor
m	Displays the KVM status
r	Switches the KVM port

#aspect

Sets the aspect ratio of the output image. The default settings is Fill Screen.

Syntax

```
#aspect
```

Parameters

param1

State

[1 ... 2]

param1	Description
1	Fill Screen
2	Keep Ratio

Example

```
#aspect 2  
aspect Keep Ratio
```

Related Commands

```
#set_output  
#show_output
```

#audio

Selects the specified audio input.

Syntax

```
#audio
```

Parameters

<i>param1</i>	Input	[1 ... 4]
---------------	-------	-----------

Example

```
#audio 3  
audio input 3
```

Related Commands

```
#kvm  
#mute  
#usb  
#video  
#video_b
```

#beeper

Enables or disables an audible “beep” each time a key is pressed. By default, this feature is *disabled*.

Syntax

```
#beeper
```

Parameters

param1 State [0 ... 1]

param1	Description
0	Off
1	On

Example

```
#beeper 1  
beeper on
```

#fadefault

Resets the unit to factory-default settings.

Syntax

```
#fadefault
```

Parameters

None

Example

```
#fadefault  
defaults restored
```

Related Commands

```
#usbreset
```

#help

Displays help on a specific command. If no command is specified (*param1*), then a list of all available commands will be displayed.

Syntax

```
#help [param1]
```

Parameters

param1 Command (optional)

Examples

```
#help
```

```
#aspect            -    Keep aspect ratio or stretch to fit the monitor
#audio            -    Switch Audio Source
#beeper           -    Activate Beeper
#fadefault       -    Restore Default Values
#help             -    Print All Commands
#hotkey           -    Hotkey Settings
#kvm              -    Switch Active KVM
...
...
#usb              -    Switch USB Hub
#upgrade          -    Firmware Upgrade
#unlink           -    Unbind peripherals from KVM port
#usbreset        -    USB Reset
#video            -    Switch Video Source
#video_b         -    Switch Auxiliary Monitor
m                 -    KVM Status
r                 -    Switch KVM Port
```

```
#help #audio
#audio    -    Switch Audio Source
```

```
Usage: #audio [x]
      x= 1 ~ 4 [inputs 1 - 4]
```

#hotkey

Defines the hotkey.

Syntax

```
#hotkey param1
```

Parameters

param1

State

[1 ... 5]

param1	Description
1	Scroll Lock
2	Caps Lock
3	Num Lock
4	Left Ctrl
5	Right Ctrl

Example

```
#hotkey 4  
hotkey Left Ctrl
```

Related Commands

```
#list
```

#kvm

Switches to the active KVM. This command is used when units are cascaded. The first unit is always 1. The second unit is 2, the third unit is 3, and so on. See [Cascading \(page 76\)](#) for more information.

Syntax

```
#kvm param1
```

Parameters

<i>param1</i>	Unit	[1 ... 8]
---------------	------	-----------

Example

```
#kvm 2
```

Related Commands

```
#audio  
#usb  
#video  
#video_b
```

#link

Binds the specified peripheral device with the KVM port.

Syntax

```
#link param1
```

Parameters

param1

Device

param1	Description
audio	Audio device
usb	USB device
video_b	Video B port

Example

```
#link audio  
link audio
```

Related Commands

```
#unlink
```

#list

Displays the list of available hotkeys.

Syntax

```
#list
```

Parameters

None

Example

```
#list  
1 [Scroll], 2 [Caps] , 3 [NumLock], 4 [Left Ctrl] , 5 [Right Ctrl]
```

Related Commands

```
#hotkey
```

#lock_edid

Locks or unlocks the EDID settings.

Syntax

```
#lock_edid param1
```

Parameters

param1 State [0 ... 1]

param1	Description
0	Unlock EDID
1	Lock EDID

Example

```
#lock_edid 1  
EDID locked
```

Related Commands

```
#set_edid  
#show_edid
```

#mode

Sets the display mode.

Syntax

```
#mode param1
```

Parameters

param1

Mode

[String]

param1	Description
full	Full-screen mode
pip	Picture-In-Picture mode
quad	Quad-picture mode
pap	Picture-And-Picture mode

Example

```
#mode quad  
mode quad
```

Related Commands

```
#pip  
#quad
```

#mute

Mutes or unmutes the audio.

Syntax

```
#mute param1
```

Parameters

param1 State [0 ... 1]

param1	Description
0	Unmute audio
1	Mute audio

Example

```
#mute 1  
mute mute
```

Related Commands

```
#audio
```

#pip

Sets the display mode to Picture-In-Picture mode and assigns the specified inputs to each window. *param1* is the main (large) window and *param2* is the smaller window.

Syntax

```
#pip param1 param2
```

Parameters

<i>param1</i>	Main display	[1 ... 4]
<i>param2</i>	Sub display	[1 ... 4]

Example

```
#pip 2 3  
pip input 2 3
```

Related Commands

```
#mode  
#quad
```

#quad

Sets the display mode to Quad mode and selects the specified input.

Syntax

```
#quad param1
```

Parameters

<i>param1</i>	Input	[1 ... 4]
---------------	-------	-----------

Example

```
#quad 3  
quad input 3
```

Related Commands

```
#mode  
#pip
```

#reboot

Reboots the unit. All settings are maintained.

Syntax

```
#reboot
```

Parameters

None

Example

```
#reboot  
EXT-DVIK-MV-41 build Nov 21 2014 - 17:40:23
```

Related Commands

```
#fadefault
```

#scan

Enables or disables PIP auto-scan. Enabling this feature will cycle through all available input sources (if connected) in the subordinate window. This command is only applicable when in PIP mode.

Syntax

```
#scan param1
```

Parameters

param1 State [1 ... 2]

param1	Description
1	Start scan
2	Stop scan

Example

```
#scan 1  
scan start scan
```

Related Commands

```
#pip
```

#set_edid

Sets the EDID mode. By default, the unit is set to External EDID.

Syntax

```
#set_edid
```

Parameters

param1 State [1 ... 2]

param1	Description
1	External EDID
2	Internal EDID

Example

```
#set_edid 2  
edid internal
```

Related Commands

```
#lock_edid  
#show_edid
```

#set_mask

Mask (disables) the video for the specified input.

Syntax

```
#set_mask param1 param2
```

Parameters

<i>param1</i>	Input	[1 ... 4]
<i>param2</i>	State	[0 ... 1]

param1	Description
0	Disable masking
1	Enable masking

Example

```
#set_mask 1 1  
mask input 1 1
```

#set_output

Sets the output resolution.

Syntax

```
#set_output param1
```

Parameters

param1

Resolution

[1 ... 9]

param1	Description
1	1920 x 1080
2	1280 x 720
3	1280 x 1024
4	1920 x 1200
5	1024 x 768
6	1680 x 1050
7	1600 x 1200
8	1360 x 768
9	Auto-select

Example

```
#set_output 5  
output 1024x768
```

Related Commands

```
#show_output
```

#show_edid

Displays the current EDID mode.

Syntax

```
#show_edid
```

Parameters

None

Example

```
#show_edid  
edid internal
```

Related Commands

```
#set_edid
```

#show_output

Displays the current output resolution.

Syntax

```
#show_output
```

Parameters

None

Example

```
#show_output  
Output resolution : 1024x768
```

Related Commands

```
#set_output
```

#show_ver_data

Displays the firmware version.

Syntax

```
#show_ver_data
```

Parameters

None

Example

```
#show_ver_data  
version:  
ID 01 : FW 1.0.2
```

Related Commands

```
#upgrade
```

#unlink

Removes the binding for the specified peripheral.

Syntax

```
#unlink param1
```

Parameters

param1

Device

param1	Description
audio	Audio device
usb	USB device
video_b	Video B port

Example

```
#unlink usb  
unlink usb
```

Related Commands

```
#link
```

#upgrade

Upgrades the firmware. See [Firmware Upgrade \(page 119\)](#) for more information.

Syntax

```
#upgrade
```

Parameters

None

Example

```
#upgrade  
Boot loader Nov 18 2014
```

Related Commands

```
#show_ver_data
```

#usb

Switches to the specified USB port.

Syntax

```
#usb param1
```

Parameters

<i>param1</i>	Input	[1 ... 4]
---------------	-------	-----------

Example

```
#usb 2  
usb input 2
```

Related Commands

```
#usbreset
```

#usbreset

Resets the USB hub.

Syntax

```
#usbreset
```

Parameters

None

Example

```
#usbreset  
Reset USB ...
```

Related Commands

```
#fadefault
```

#video

Switches to the specified video input.

Syntax

```
#video param1
```

Parameters

<i>param1</i>	Input	[1 ... 4]
---------------	-------	-----------

Example

```
#video 2  
video input 2
```

Related Commands

```
#set_mask  
#video_b  
r
```

#video_b

Switches to the specified input on the auxiliary (Video B) monitor.

Syntax

```
#video_b param1
```

Parameters

<i>param1</i>	Input	[1 ... 4]
---------------	-------	-----------

Example

```
#video_b 3  
video_b input 3
```

Related Commands

```
#audio  
#usb  
#video  
r
```

m

Displays the current KVM status. Do not precede this command with the “#” symbol.

Syntax

```
m
```

Parameters

None

Example

```
m  
video 2  
usb 4  
audio 1  
aux 2
```

Related Commands

```
#audio  
#usb  
#video  
#video_b  
r
```

r

Switches to the specified KVM port. Do not precede this command with the “#” symbol.

Syntax

```
r param1
```

Parameters

<i>param1</i>	Input	[1 ... 4]
---------------	-------	-----------

Example

```
r 3  
input 3
```

Related Commands

```
#audio  
#kvm  
#usb  
#video  
#video_b
```

4x1 DVI KVM Multiview Switcher

4

Appendix

OSD

Setting	Value
Hotkey	Scroll
Link USB	Yes
Link Audio	Yes
Link Video B	Yes
OSD Timeout	30
Titlebar Timeout	5
Show PC Name	Yes
Show Video Signal	Yes
Output Resolution	Auto
Shrink Control	Fill
EDID Mode	External
One-Click Switching	Wheel
PIP Scan Period	10
Input 1	PC01
Input 2	PC02
Input 3	PC03
Input 4	PC04

Hotkeys

Hotkey	Description
ScrLk + ScrLk + (X)	Selects KVM port <i>X</i> <i>X</i> = Input 1 ... Input 4
ScrLk + ScrLk + A + (X)	PAP mode <i>X</i> = Input 1 ... Input 4
ScrLk + ScrLk + B	Toggle beep sound
ScrLk + ScrLk + BckSpC	Select the previously-selected KVM port
ScrLk + ScrLk + C	Enable PC and audio binding
ScrLk + ScrLk + Del	Unbind primary and auxiliary monitor switching
ScrLk + ScrLk + ↓	Selects the next KVM port
ScrLk + ScrLk + F + (X)	Enables Full mode using input <i>X</i> <i>X</i> = Input 1 ... Input 4
ScrLk + ScrLk + F1	Switch to hub port 1
ScrLk + ScrLk + F2	Switch to hub port 2
ScrLk + ScrLk + F3	Switch to hub port 3
ScrLk + ScrLk + F4	Switch to hub port 4
ScrLk + ScrLk + F5	Switch to audio port 1
ScrLk + ScrLk + F6	Switch to audio port 2
ScrLk + ScrLk + F7	Switch to audio port 3
ScrLk + ScrLk + F8	Switch to audio port 4
ScrLk + ScrLk + F9	Switch Video B (auxiliary monitor) to port 1
ScrLk + ScrLk + F10	Switch Video B (auxiliary monitor) to port 2
ScrLk + ScrLk + F11	Switch Video B (auxiliary monitor) to port 3
ScrLk + ScrLk + F12	Switch Video B (auxiliary monitor) to port 4
ScrLk + ScrLk + H + (Y)	Defines the hotkey <i>Y</i> = ScrLk, Caps, Num Lock, L Ctrl, R Ctrl
ScrLk + ScrLk + I + (X) ScrLk + ScrLk + P + (X)	Enable PIP mode and assigns input <i>X</i> to the main / subordinate display <i>I</i> = main display, <i>P</i> = subordinate display <i>X</i> = Input 1 ... Input 4
ScrLk + ScrLk + Ins	Bind Video A (primary) and Video B (auxiliary) switching
ScrLk + ScrLk + K + (X)	Switches to the specified unit, when cascading
ScrLk + ScrLk + O	Enables the display mode menu
ScrLk + ScrLk + Q + (X)	Enables Quad mode and selects window <i>X</i> <i>X</i> = Input 1 ... Input 4
ScrLk + ScrLk + S + (X)	Toggles PIP auto-scan

Hotkey	Description
ScrLk + ScrLk + Space Bar	Displays the OSD
ScrLk + ScrLk + T	Toggles the title bar
ScrLk + ScrLk + ↕	Selects the next port
ScrLk + ScrLk + V	Disable PC and audio binding
ScrLk + ScrLk + W	Swaps the main and subordinate window in PIP mode
ScrLk + ScrLk + X	Unbinds PC and USB switching
ScrLk + ScrLk + Z	Binds PC and USB switching

Using the USB Port

1. Download and install USB Loader from Gefen website.
2. Launch the USB Loader program.
3. Connect a USB cable, from the computer running the USB Loader program, to the **USB Host** port on the **Source 1** input.

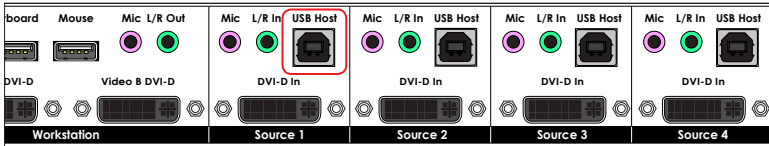

4. Power OFF the 4x1 DVI KVM Multiview Switcher.
5. Press and hold the **Source 1** button on the front panel.

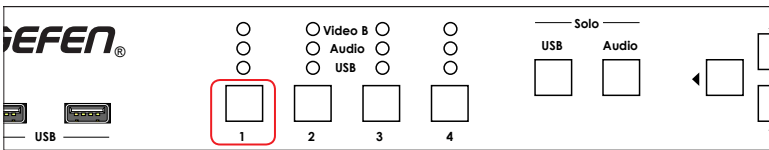

6. Power ON the switcher.
7. The display mode buttons will flash.

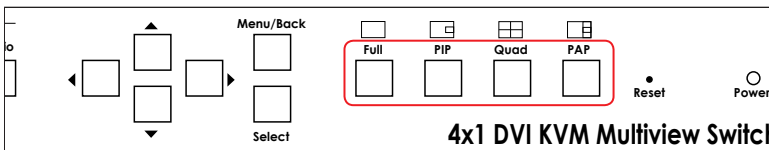

8. Select the firmware file using the USB Loader program: `kvm-[version].bin`.
9. Click the **Upgrade** button.
10. After the upgrade progress completes, click the **OK** button.
11. Reboot the unit using the **Reboot** button on the USB Loader program.
12. The upgrade process is complete.

Using the RS-232 Port

1. Download and install USB Loader from Gefen website.
2. Launch the USB Loader program.
3. Connect an RS-232 cable or automation system, that will be sending RS-232 commands, to the **RS-232 In** port.
4. Connect a USB cable, from the computer running the USB Loader program, to the **USB Host** port on the **Source 1** input.

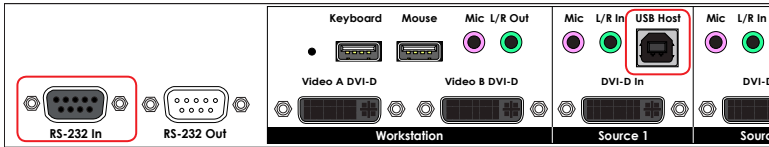

5. Execute the `#upgrade` command.
6. The display mode buttons will flash.

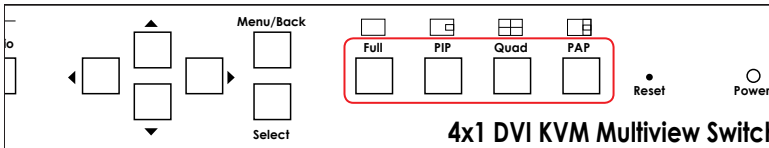

7. Select the firmware file using the USB Loader program: `kvm-[version].bin`.
8. Click the **Upgrade** button.
9. After the upgrade progress completes, click the **OK** button.
10. Reboot the unit using the **Reboot** button on the USB Loader program.
11. The upgrade process is complete.

Using the OSD

1. Download and install USB Loader from Gefen website.
2. Launch the USB Loader program.
3. Connect a USB cable, from the computer running the USB Loader program, to the **USB Host** port on the **Source 1** input.

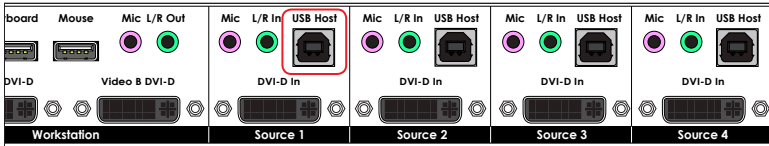

4. Select [Upgrade Firmware \(page 70\)](#) from the OSD menu.
5. The display mode buttons will flash.

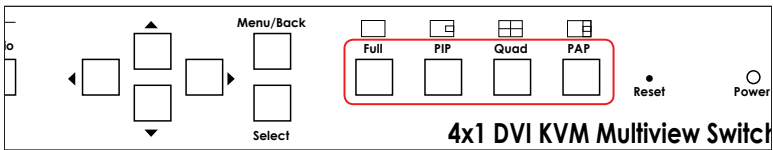

6. Select the firmware file using the USB Loader program: `kvm-[version].bin`.
7. Click the **Upgrade** button.
8. After the upgrade progress completes, click the **OK** button.
9. Reboot the unit using the **Reboot** button on the USB Loader program.
10. The upgrade process is complete.

Connectors, Controls, and Indicators	
Video Input	<ul style="list-style-type: none"> 4 x DVI-I, 29-pin, female (digital only)
Video Output	<ul style="list-style-type: none"> 2 x DVI-I, 29-pin, female (digital only)
USB (front panel)	<ul style="list-style-type: none"> 2 x Type A, 5V DC at 1A max shared current
USB (rear panel)	<ul style="list-style-type: none"> 2 x Type A, 5V DC at 1A max shared current 4 x Type B
Microphone	<ul style="list-style-type: none"> 1 x 3.5mm mini-mono (input) 4 x 3.5mm mini-mono (output)
L/R Audio	<ul style="list-style-type: none"> 4 x 3.5mm mini-stereo (input) 1 x 3.5mm mini-stereo (output)
RS-232	<ul style="list-style-type: none"> 1 x DB-9, female (input) 1 x DB-9, male (output)
Power switch	<ul style="list-style-type: none"> 1 x rocker-type
Grounding	<ul style="list-style-type: none"> 1 x machine screw (rear chassis)
Front Panel Buttons	<ul style="list-style-type: none"> 10 x tact-type, blue backlight 6 x tact-type
Power Supply Connector	<ul style="list-style-type: none"> 1 x 3-pin, locking
Power Indicator	<ul style="list-style-type: none"> 1 x LED, blue
Video B Indicator	<ul style="list-style-type: none"> 4 x LED, blue
Audio Indicator	<ul style="list-style-type: none"> 4 x LED, blue
USB Indicator	<ul style="list-style-type: none"> 4 x LED, blue

Operational	
Maximum Pixel Clock	<ul style="list-style-type: none"> 165 Mhz
Maximum TMDS Clock	<ul style="list-style-type: none"> 165 MHz
Power Supply	<ul style="list-style-type: none"> 12V DC
Power Consumption	<ul style="list-style-type: none"> 40W maximum
Operating Temperature	<ul style="list-style-type: none"> +32 to +122 °F (0 to +50 °C)
Operating Humidity	<ul style="list-style-type: none"> 5% to 90% RH, non-condensing
Storage Temperature	<ul style="list-style-type: none"> -4 to +185 °F (-20 to +85 °C)
Relative Humidity	<ul style="list-style-type: none"> 0% to 95% RH, non-condensing
MTBF	<ul style="list-style-type: none"> 50000 hours

Physical	
Dimensions (W x H x D)	<ul style="list-style-type: none"> 17.2" x 1.2" x 7.9" (437mm x 30mm x 200mm)
Unit Weight	<ul style="list-style-type: none"> 3.7 lbs (1.6 kg)



20600 Nordhoff St., Chatsworth CA 91311
1-800-545-6900 818-772-9100 fax: 818-772-9120
www.gefen.com support@gefen.com