

4x4 Seamless Matrix for HDMI

EXT-HD-SL-444

User Manual

Release A5



Important Safety Instructions

GENERAL SAFETY INFORMATION

1. Read these instructions.
2. Keep these instructions.
3. Heed all warnings.
4. Follow all instructions.
5. Do not use this product near water.
6. Clean only with a dry cloth.
7. Do not block any ventilation openings. Install in accordance with the manufacturer's instructions.
8. Do not install or place this product near any heat sources such as radiators, heat registers, stoves, or other apparatus (including amplifiers) that produce heat.
9. Do not defeat the safety purpose of the polarized or grounding-type plug. A polarized plug has two blades with one wider than the other. A grounding type plug has two blades and a third grounding prong. The wide blade or the third prong are provided for your safety. If the provided plug does not fit into your outlet, consult an electrician for replacement of the obsolete outlet.
10. Protect the power cord from being walked on or pinched particularly at plugs, convenience receptacles, and the point where they exit from the apparatus.
11. Only use attachments/accessories specified by the manufacturer.
12. To reduce the risk of electric shock and/or damage to this product, never handle or touch this unit or power cord if your hands are wet or damp. Do not expose this product to rain or moisture.
13. Unplug this apparatus during lightning storms or when unused for long periods of time.
14. Refer all servicing to qualified service personnel. Servicing is required when the apparatus has been damaged in any way, such as power-supply cord or plug is damaged, liquid has been spilled or objects have fallen into the apparatus, the apparatus has been exposed to rain or moisture, does not operate normally, or has been dropped.
15. Batteries that may be included with this product and/or accessories should never be exposed to open flame or excessive heat. Always dispose of used batteries according to the instructions.

Warranty Information

Gefen warrants the equipment it manufactures to be free from defects in material and workmanship.

If equipment fails because of such defects and Gefen is notified within two (2) years from the date of shipment, Gefen will, at its option, repair or replace the equipment, provided that the equipment has not been subjected to mechanical, electrical, or other abuse or modifications. Equipment that fails under conditions other than those covered will be repaired at the current price of parts and labor in effect at the time of repair. Such repairs are warranted for ninety (90) days from the day of reshipment to the Buyer.

This warranty is in lieu of all other warranties expressed or implied, including without limitation, any implied warranty or merchantability or fitness for any particular purpose, all of which are expressly disclaimed.

1. Proof of sale may be required in order to claim warranty.
2. Customers outside the US are responsible for shipping charges to and from Gefen.
3. Copper cables are limited to a 30 day warranty and cables must be in their original condition.

The information in this manual has been carefully checked and is believed to be accurate. However, Gefen assumes no responsibility for any inaccuracies that may be contained in this manual. In no event will Gefen be liable for direct, indirect, special, incidental, or consequential damages resulting from any defect or omission in this manual, even if advised of the possibility of such damages. The technical information contained herein regarding the features and specifications is subject to change without notice.

For the latest warranty coverage information, refer to the Warranty and Return Policy under the Support section of the Gefen Web site at www.gefen.com.

PRODUCT REGISTRATION

Please register your product online by visiting the Register Product page under the Support section of the Gefen Web site.

Contacting Gefen Technical Support

Gefen, LLC
c/o Customer Service
20600 Nordhoff St.
Chatsworth, CA 91311

Telephone: (818) 772-9100
(800) 545-6900

Fax: (818) 772-9120

Email: support@gefen.com

Visit us on the Web: www.gefen.com

Technical Support Hours: 8:00 AM to 5:00 PM Monday - Friday, Pacific Time

4x4 Seamless Matrix for HDMI is a trademark of Gefen, LLC.

Important Notice

Gefen, LLC reserves the right to make changes in the hardware, packaging, and any accompanying documentation without prior written notice.

HDMI, the HDMI logo, and High-Definition Multimedia Interface are trademarks or registered trademarks of HDMI Licensing in the United States and other countries.

© 2014 Gefen, LLC. All Rights Reserved.
All trademarks are the property of their respective owners.

Operating Notes

- When using the 4x4 Seamless Matrix for HDMI for the first time, it is recommended that the unit be configured using the Gefen Syner-G Software Suite. The Gefen Syner-G Software Suite is free software that is available from the Support > Downloads section of the Gefen Web site.

Features and Packing List

Features

- Seamless matrix scales each of its four inputs, and routes them to any or all of the four outputs without frame loss
- Input and Output resolutions up to 1080p Full HD and 1920x1200 (WUXGA)
- HDCP compliant
- Seamless switching ensures no switching delay and no picture loss during transitions
- Ten user-configurable routing presets can be accessed via front panel push-buttons
- Controllable via front panel controls, IR, IP (web server interface, Telnet, and UDP), and RS-232
- Easy to use on-screen Graphical User Interface (GUI)
- Handheld IR remote control and IR Extender input on back panel
- Field-upgradable firmware via web server interface
- USB port (reserved for future product enhancements)
- Locking power supply connector
- 1U tall rack-mountable enclosure, rack ears included



Packing List

The 4x4 Seamless Matrix for HDMI ships with the items listed below. If any of these items are not present in your box when you first open it, immediately contact your dealer or Gefen.

- 4x4 Seamless Matrix for HDMI
- 4 x 6 ft. Locking HDMI Cables
- 1 x 6 ft. DB-9 Cable
- 1 x IR Extender Module
- 1 x IR Remote Control
- 1 x 12V DC Locking Power Supply
- 1 x Set of Rack Ears
- 1 x Quick-Start Guide

Table of Contents

01 Getting Started

Panel Layout	2
Front	2
Back	3
IR Remote Control Unit	4
Top	4
Bottom	6
Battery Cover	6
Installing the Batteries	7
Battery Cover	7
Setting the IR Channel	8
Installation	9
Connecting the 4x4 Seamless Matrix for HDMI	9
Sample Wiring Diagram	9

02 Operating the 4x4 Seamless Matrix for HDMI

Introduction	12
Standby Mode	12
Turning on the 4x4 Seamless Matrix for HDMI	12
Routing Basics	13
Determining the Current Routing State	13
Routing Inputs to Outputs	14
Masking / Unmasking Outputs	16
Saving Routing Presets	18
Loading Routing Presets	19
Locking / Unlocking the Matrix	20
Using the IR Extender	22
Menu System	23
Accessing the Menu System	23
Setting the Output Resolution	26
Adjusting the Contrast	28
Adjusting the Brightness	30
Adjusting the Saturation	32
Adjusting the Hue	34
OSD Settings	36
HDCP	40
EDID Management	42
Changing the IP Settings	44
Changing the Telnet Settings	47
Changing the UDP Settings	49
System Settings	51

03 Advanced Operation

RS-232 and IP Configuration	54
RS-232 Interface	54
RS-232 Settings	54
IP / UDP Configuration	55
Commands	56
Web Interface	112
Using the built-in Web Interface	112
Main ► Routing	113
Main ► I/O Status	117
Main ► Display Info	119
I/O Setup ► Preset Names	120
I/O Setup ► I/O Names	121
I/O Setup ► HPD Control	122
I/O Setup ► HDCP	123
I/O Setup ► Video	125
Manage EDID ► Assign	127
Manage EDID ► Bank Names	131
Manage EDID ► Upload / Download	132
Network	134
System	138

04 Appendix

Upgrading the Firmware	142
Using the Web Interface	142
Using the USB Interface	143
Specifications	144

4x4 Seamless Matrix for HDMI

01 Getting Started

Panel Layout	2
Front	2
Back	3
IR Remote Control Unit	4
Top	4
Bottom	6
Battery Cover	6
Installing the Batteries	7
Battery Cover	7
Setting the IR Channel	8
Installation	9
Connecting the 4x4 Seamless Matrix for HDMI	9
Sample Wiring Diagram	9

Panel Layout

Front

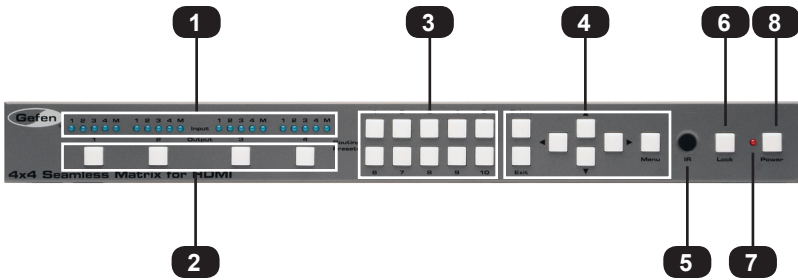

ID	Name	Description
1	Input Indicators	These blue LED indicators display the state of each input. See Routing Basics for more information.
2	Output Selection Buttons (1 - 4)	Press these buttons to select the desired output. See Routing Basics for more information.
3	Routing Presets (1 - 10)	Press these buttons to select the desired routing preset. See Saving Routing Presets for more information.
4	Menu System Controls	Use these buttons to select and change settings within the built-in menu system. See Menu System for more information.
5	IR	This IR sensor receives signals from the included IR remote control unit.
6	Lock	Use this button to lock the matrix and prevent accidental changes. See Locking / Unlocking the Matrix for more information on this feature.
7	Standby LED Indicator	This LED will remain illuminated when the matrix is powered OFF.
8	Power	This button is used to power ON and power OFF the matrix. This button will remain illuminated while the matrix is powered ON.

Back

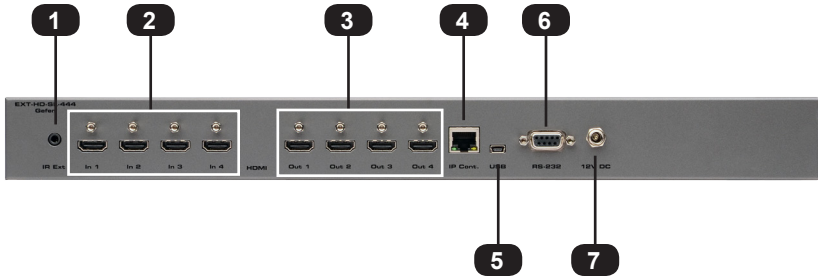

ID	Name	Description
1	IR Ext	Connect the included IR Extender (Gefen part no. EXT-RMT-EXTIRN) to this port.
2	In (1 - 4)	Connect up to four Hi-Def sources to these inputs using the included HDMI cables.
3	Out (1 - 4)	Connect up to four HDTV displays to these HDMI outputs.
4	IP Cont.	Connect an Ethernet cable between this jack and a LAN to use IP control. See IP / UDP Configuration for details on using IP control.
5	USB	Used for upgrading the firmware. See Upgrading the Firmware for more information.
6	RS-232	Connect an RS-232 cable from this port to an RS-232 device. See RS-232 and IP Configuration for more information on setting up RS-232 serial control.
7	12V DC	Connect the included 12V DC power supply from this power receptacle to an available AC electrical outlet. Do not overtighten the locking connector on the power receptacle.

IR Remote Control Unit

Top

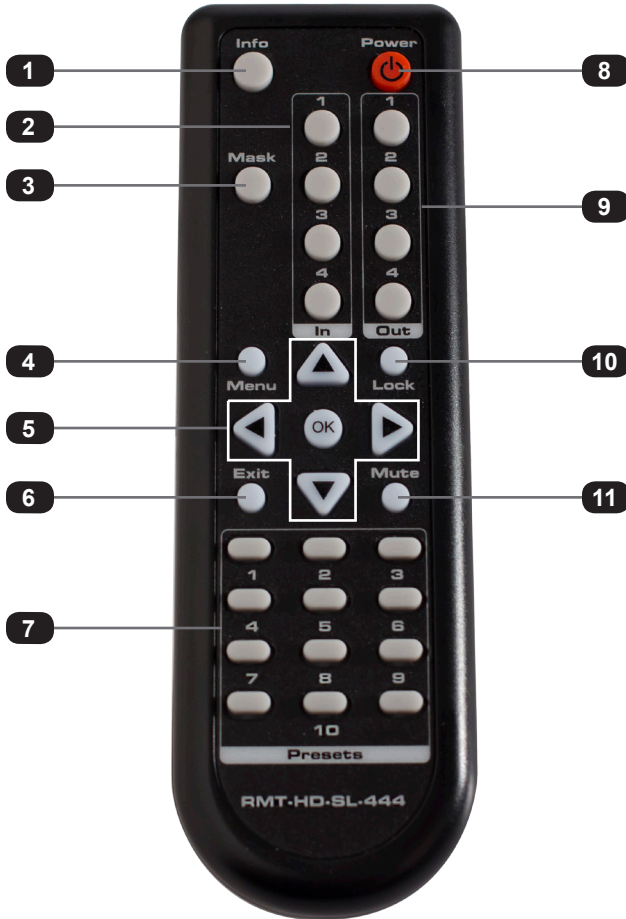

ID	Name	Description
1	Info	Used to toggle notifications on all outputs.
2	In (1 - 4)	Use these buttons to select the desired input. See Routing Basics for more information on routing inputs to outputs.

ID	Name	Description
3	Mask	Press this button to mask or unmask the selected output. See Masking / Unmasking Outputs for more information.
4	Menu	Press this button to display the built-in menu system.
5	◀/▶/▲/▼/OK	Used to access and change features within the menu system. Use the arrow buttons to move around within the menu system or change a value. Press the OK button to make a selection within the menu system.
6	Exit	Press this button to exit the main menu or exit from sub-menus.
7	Presets	Use these button to select the desired routing preset. The buttons below 7 and 9 are not used. See Saving Routing Presets for more information on working with routing presets.
8	Power	Press this button to power-ON or power-OFF the matrix.
9	Out (1 - 4)	Use these buttons to select the desired input. See Routing Basics for more information on routing inputs to outputs.
10	Lock	Press this button to lock / unlock the matrix.
11	Mute	Mutes the audio on all outputs.

Bottom

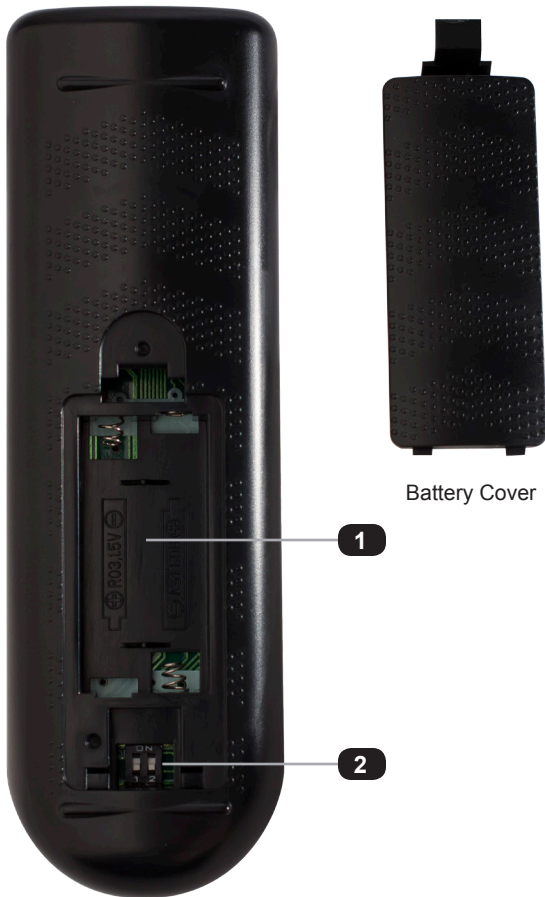

ID	Name	Description
1	Battery slot (shown without batteries)	Holds the batteries for operating the IR remote. Use only 1.5V "AAA"-type batteries. See Installing the Batteries for more information.
2	DIP switch bank	Use these DIP switches to set the IR channel of the remote. See Setting the IR Channel for details.

Installing the Batteries

1. Remove the battery cover on the bottom of the IR remote control unit.
2. Make sure that the batteries are installed with the correct polarity, as shown in the illustration, below. Always use two 1.5V AAA-type batteries.
3. Replace the battery cover.







WARNING: Risk of explosion if battery is replaced by an incorrect type. Dispose of used batteries according to the instructions.

Setting the IR Channel

In order for the included IR remote control to communicate with the matrix, the IR remote control must be set to the same channel as the matrix. The IR channel of the matrix is set through the [System](#) page in the Web interface.



DIP switches

IR Channel	DIP settings
0 (default)	
1	
2	
3	

Installation

Connecting the 4x4 Seamless Matrix for HDMI

1. Connect up to four Hi-Def sources to the input ports (**In 1 - In 4**) ports on the matrix.
2. Connect up to four HD displays using the output ports (**Out 1 - Out 4**) on the matrix.
3. OPTIONAL: Connect an RS-232 cable from the **RS-232** port on the matrix to the RS-232 connector on the serial controller (e.g. Gefen PACS, etc).
4. OPTIONAL: Connect an Ethernet cable from the **IP Control** port on the matrix to a Local Area Network (LAN).
5. OPTIONAL: Connect the included IR extender to the **IR Ext** port on the matrix.
6. Connect the included 12V DC locking power supply to the power receptacle on the matrix. Do not overtighten the locking power connector.
7. Connect the power supply to an available electrical outlet.

Sample Wiring Diagram

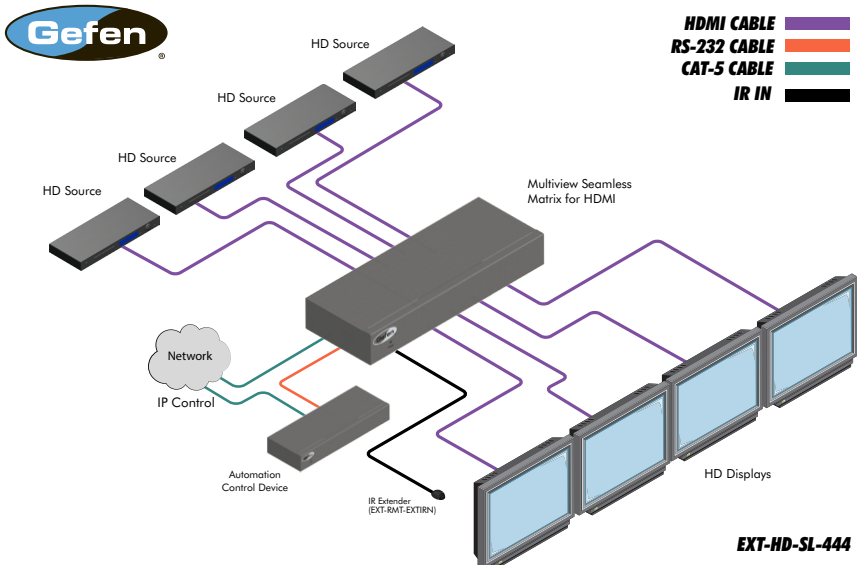

4x4 Seamless Matrix for HDMI

02 Operating the 4x4 Seamless Matrix for HDMI

Introduction.....	12
Standby Mode.....	12
Turning on the 4x4 Seamless Matrix for HDMI.....	12
Routing Basics.....	13
Determining the Current Routing State.....	13
Routing Inputs to Outputs.....	14
Masking / Unmasking Outputs.....	16
Saving Routing Presets.....	18
Loading Routing Presets.....	19
Locking / Unlocking the Matrix.....	20
Using the IR Extender.....	22
Menu System.....	23
Accessing the Menu System.....	23
Setting the Output Resolution.....	26
Adjusting the Contrast.....	28
Adjusting the Brightness.....	30
Adjusting the Saturation.....	32
Adjusting the Hue.....	34
OSD Settings.....	36
HDCP.....	40
EDID Management.....	42
Changing the IP Settings.....	44
Changing the Telnet Settings.....	47
Changing the UDP Settings.....	49
System Settings.....	51

Introduction

Standby Mode

The LED next to the **Power** button, on the front panel, indicates the power state of the 4x4 Seamless Matrix for HDMI. In *standby mode*, power is being supplied to the 4x4 Seamless Matrix for HDMI but the unit is not turned on. This LED will be red and remain illuminated as long as the unit is in *standby mode*. If this LED does not illuminate, check the connection between the power receptacle on the 4x4 Seamless Matrix for HDMI and the AC outlet.

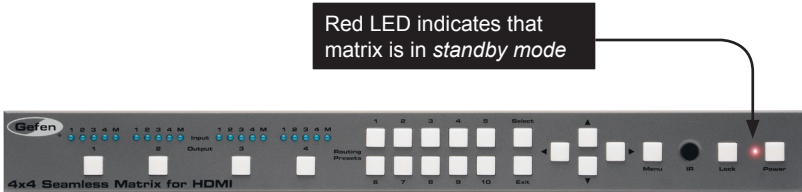

Turning on the 4x4 Seamless Matrix for HDMI

Press the **Power** button to power-on the matrix. The **Power** button will turn blue and remain illuminated as long as the matrix is powered-on. To power-off the 4x4 Seamless Matrix for HDMI and return to *standby mode*, press the **Power** button again.

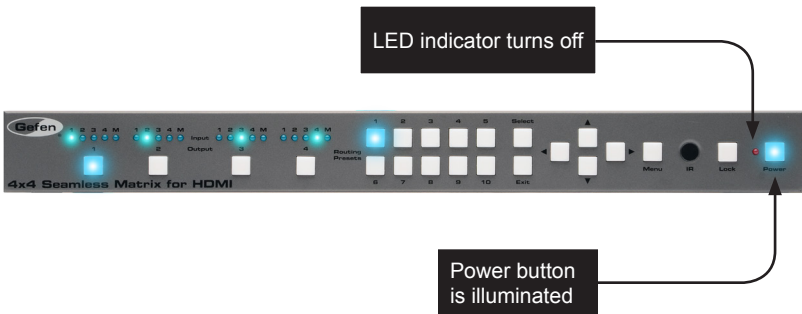

Routing Basics

Determining the Current Routing State

On the top-left portion of the matrix, there are four sets of five LED indicators. Each set of five LED indicators resides above each of the four **Output** buttons.



LED indicators 1 through 4 represent each input on the matrix. If one of these LED indicators are illuminated, then that means that the input is active.

The “M” LED indicates that the output is masked. Refer to [Masking / Unmasking Outputs](#) for more information on masking and unmasking outputs.

Each of the Output buttons are used to route inputs to outputs. When an Output button is illuminated, it represent the currently selected output. For example, in the illustration below, we can see that Input 1 has been routed to Output 1:

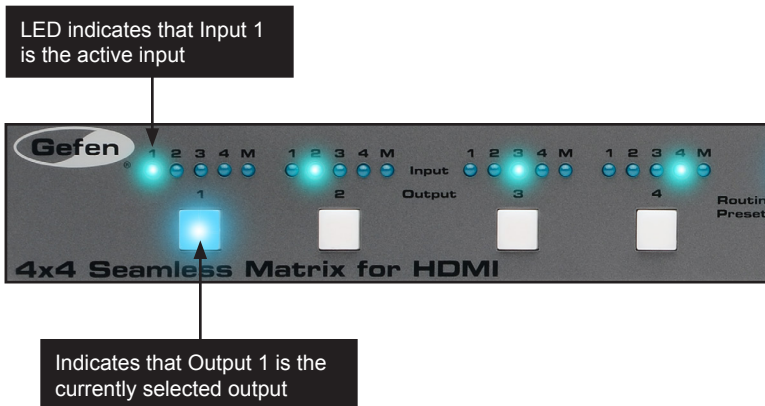

In addition, we can also see that Input 2 is routed to Output 2, Input 3 is routed to Output 3, and Input 4 is routed to Output 4. If the number of the input is the same as the number of the output, then this is called the “one-to-one” routing state. This is the factory-default routing state of the matrix.

Routing Inputs to Outputs

Using the Front Panel Buttons

To change the routing state of an output, press and release the button of the desired output to advance to the next input.

In the illustration below, the source connected to Input 2 is currently routed to Output 2. For this example, we will route Input 4 to Output 2.



1. Select output 2 by pressing button **Output 2**. The LED for Input 2 is illuminated, indicating that Input 2 is currently routed to **Output 2**.



Output 2 is selected

2. Press button **Output 2**, twice.

Input 4 is selected



3. The LED indicator for Input 4 is now illuminated. This indicates that Input 4 is now routed to Output 2.

Once an output is selected, it will remain illuminated until another output is selected. An output must be selected before making a routing change.

Using the IR Remote Control

We'll use with the same routing example that is outlined on the previous page. However, instead of using the buttons on the front panel, we will use the IR remote control.

Input 2 is routed to Output 2. We will use the IR remote to route Input 4 to Output 2.



1. Point the IR remote at the IR sensor on the front panel of the matrix.
2. Select the desired output. In this example, we will select Output 2. Always select the output *before* selecting the input.



3. Select the desired input. In this example, we will select Input 4.



4. The LED indicator for Input 4 is now illuminated. Input 4 is now routed to Output 2.

Masking / Unmasking Outputs

"Masking" prevents the output device (display, etc) from receiving an output signal. Instead of powering-down or disconnecting the output device, individual or multiple outputs can be masked.

Using the Front Panel Buttons

1. Press the button of the desired output to be masked. For this example, we will select Output 2:

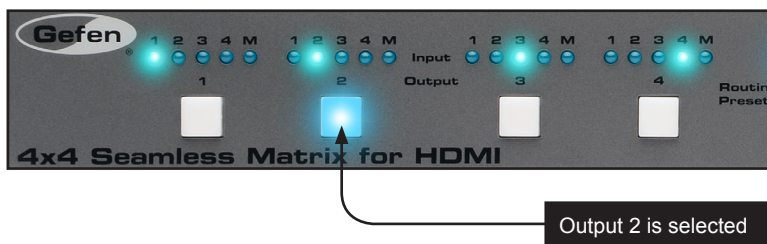

2. Continue pressing the button for Output 2 until the "M" LED indicator is illuminated.



3. To unmask an output, press the button for the output and select the desired input. See [Routing Inputs to Outputs](#) for more information.

Using the IR Remote Control

1. Press the button of the desired output to be masked. For this example, we will select Output 3:



2. Press the **Mask** button.
3. Both the selected output and the "M" LED indicator will be illuminated on the front panel of the matrix.

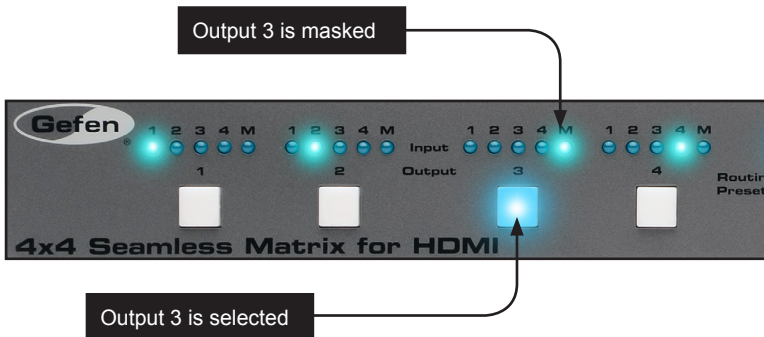

4. To unmask an output, press the button for the output and then select the desired input. See [Routing Inputs to Outputs](#) for more information.

Saving Routing Presets

The 4x4 Seamless Matrix for HDMI allows routing states to be saved to any of 10 preset memory locations. Presets are retained in memory even if the matrix is powered OFF.

 **NOTE:** Routing presets cannot be saved using the IR remote control unit.

1. Create the desired routing state.



In the example, above, we have masked Output 1, and set Input 2 to Output 2, Input 3 to Output 3, and so on. Note that when saving a routing state, any outputs that are masked are also saved to memory.

2. Let's save this configuration to Preset 1. *Press and hold* button 1 on the Routing Presets section, on the front panel.

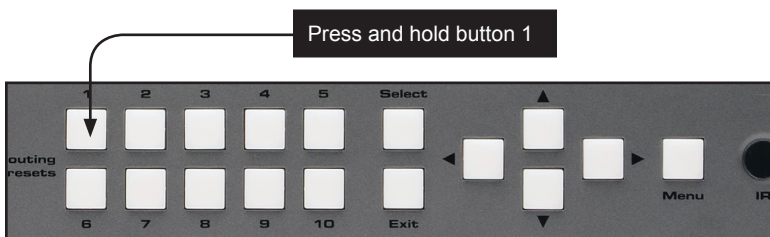

3. After a few seconds, button 1 will turn on and remain illuminated, indicating that the current routing configuration has been saved.

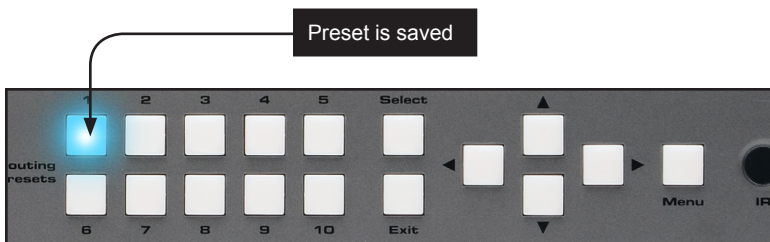

Loading Routing Presets

Using the Front Panel Buttons

1. Press the desired **Routing Preset** button.

The routing preset will be loaded into memory. In the example below, we have selected Routing Preset 3.

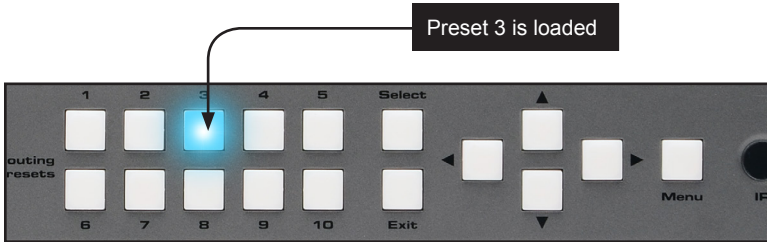

The selected button will remain illuminated as long as the preset is selected.

Using the IR Remote Control

1. Press the desired Preset button on the IR remote control. Note that the buttons below button 7 and 9 are not used.

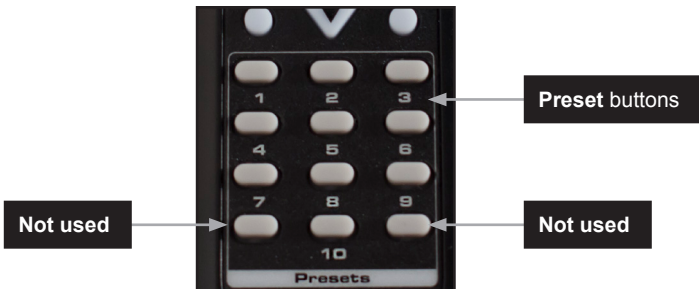

2. The routing preset will be loaded into memory. The associated Routing Preset button, on the matrix, will remain illuminated as long as the preset is selected.

Locking / Unlocking the Matrix

Locking the matrix will prevent any changes by disabling all buttons (except the Lock button) on the front panel. This feature is useful in preventing routing or other changes caused by accidentally bumping or pressing the buttons on the front panel.

Using the Front Panel Buttons

1. Press and hold the **Lock** button on the front panel. The **Lock** button will begin to flash.
2. Continue holding down the **Lock** button until it stops flashing.
3. The matrix is now locked. The **Lock** button will remain illuminated as long as the matrix is locked.

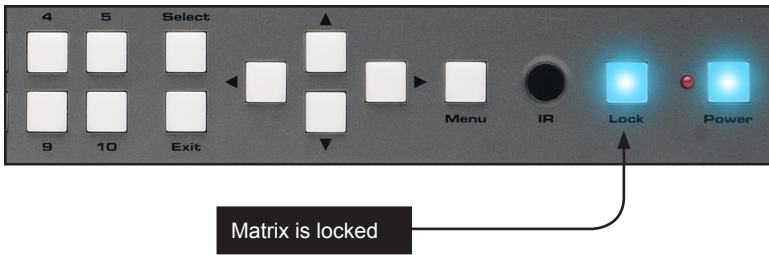

4. To unlock the matrix, press and hold the **Lock** button. The **Lock** button will begin to flash.
5. Continue holding down the **Lock** button until it stops flashing.
6. The matrix is now unlocked and can be used normally.

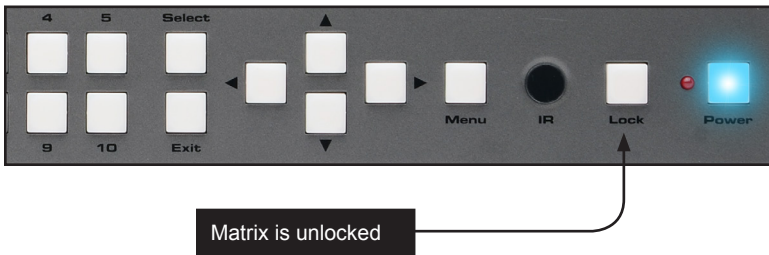

Once the matrix is unlocked, the **Lock** button will no longer be illuminated.

Using the IR Remote Control

1. Press the **Lock** button on the IR remote control.

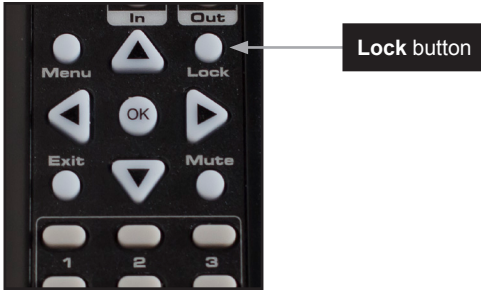

2. The **Lock** button, on the front panel of the matrix, will remain illuminated as long as the matrix is locked.

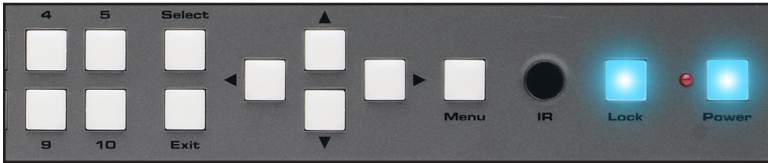

3. To unlock the matrix, press the **Lock** button. The **Lock** button will turn off.

The matrix is now unlocked and can be used normally.

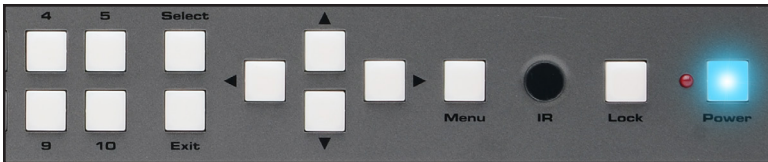

Once the matrix is unlocked, the **Lock** button will no longer be illuminated.

Using the IR Extender

There may be situations where the IR sensor is blocked by a cabinet or other mounting device. In this case, the included IR extender (Gefen part no. EXT-RMT-EXTIRN) can be connected to the **IR Ext** port on the matrix. The sensor on the IR extender behaves exactly like the sensor on the front panel of the matrix. Always point the IR remote control unit in the direction of the IR sensor.

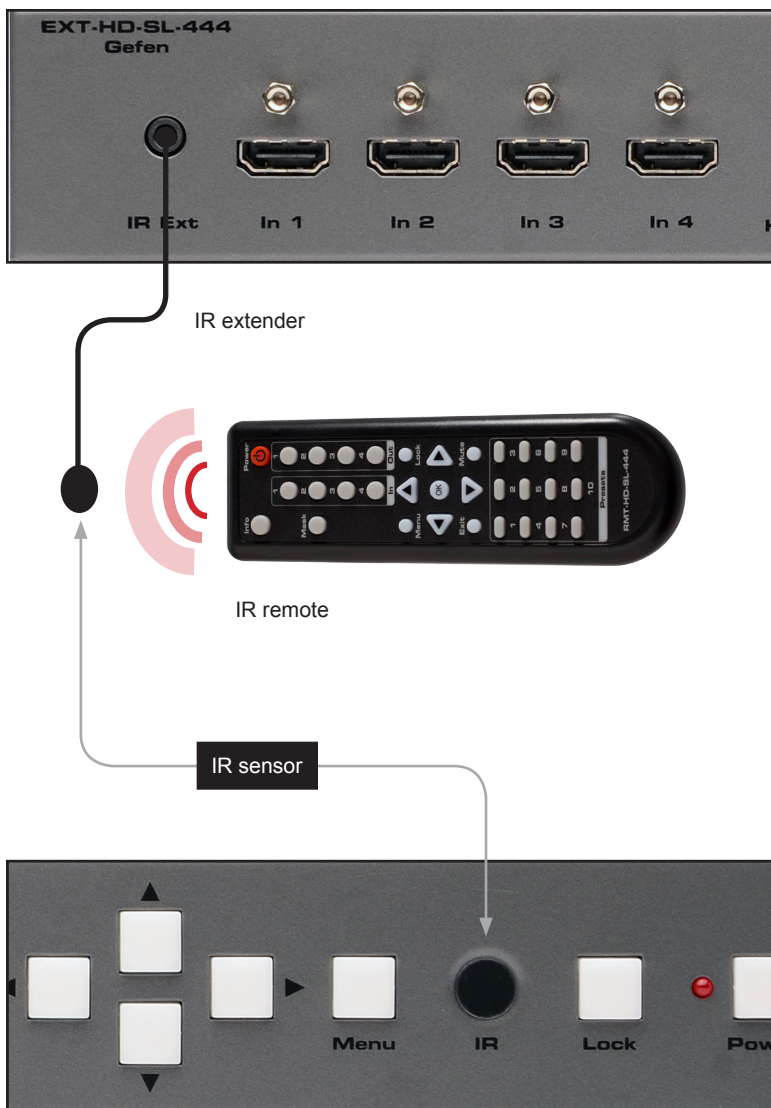

Menu System

Accessing the Menu System

The matrix uses a built-in menu system to manage and control all video features. To access the menu system, press the **Menu** button on the front panel or on the included IR remote control.

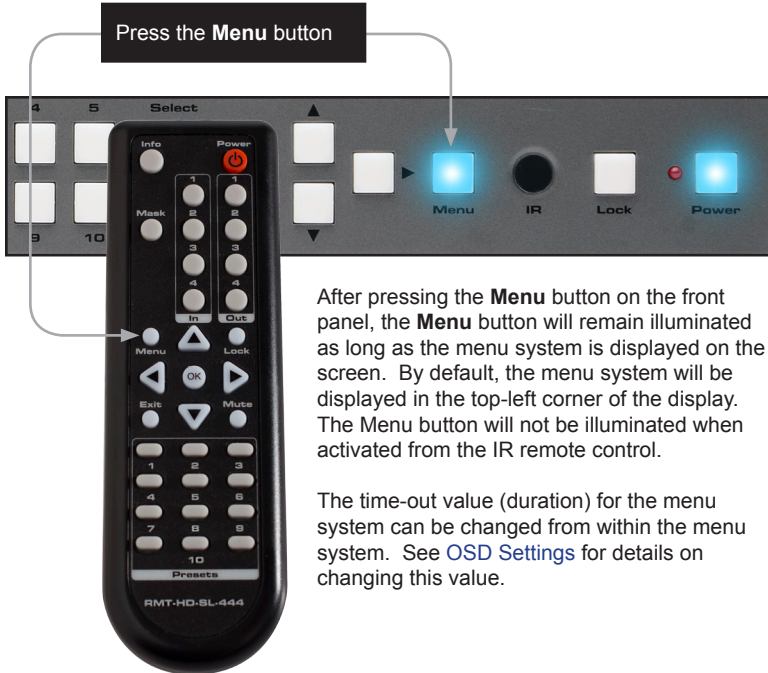
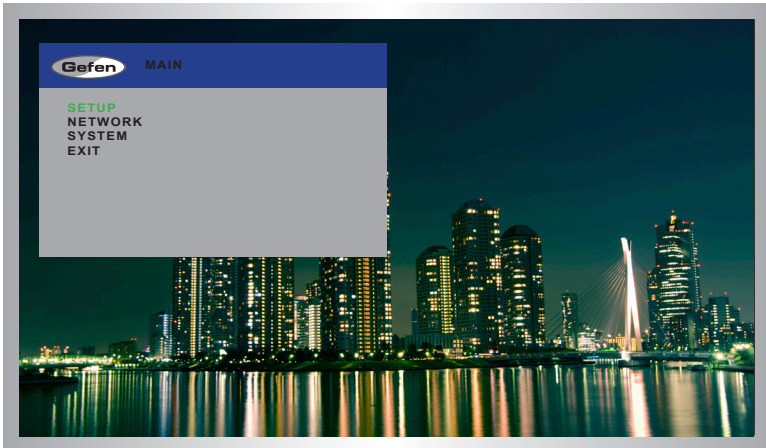

After pressing the **Menu** button on the front panel, the **Menu** button will remain illuminated as long as the menu system is displayed on the screen. By default, the menu system will be displayed in the top-left corner of the display. The Menu button will not be illuminated when activated from the IR remote control.

The time-out value (duration) for the menu system can be changed from within the menu system. See [OSD Settings](#) for details on changing this value.

Using the Front Panel Controls

Use the ◀, ▶, ▲, and ▼ buttons on the front panel to move around within the menu system. Press the ▲ and ▼ buttons to move up and down. Press the ◀ or ▶ buttons to change the value of the current selection. Press the **Select** button to make the desired selection. The current selection will be highlighted in green.

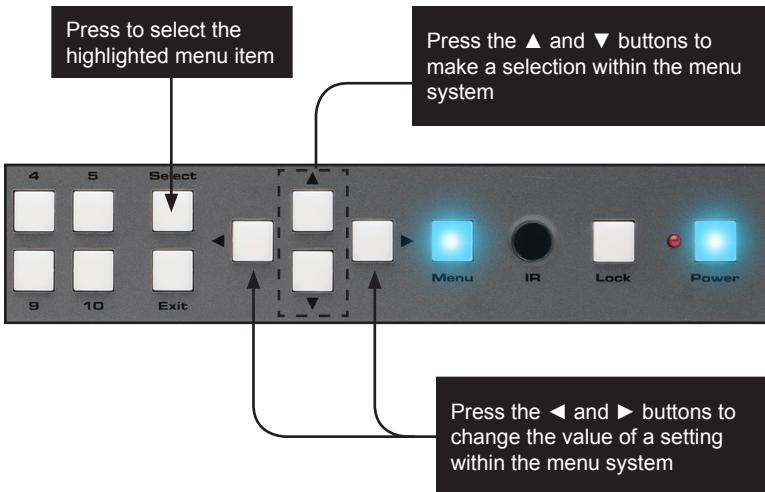
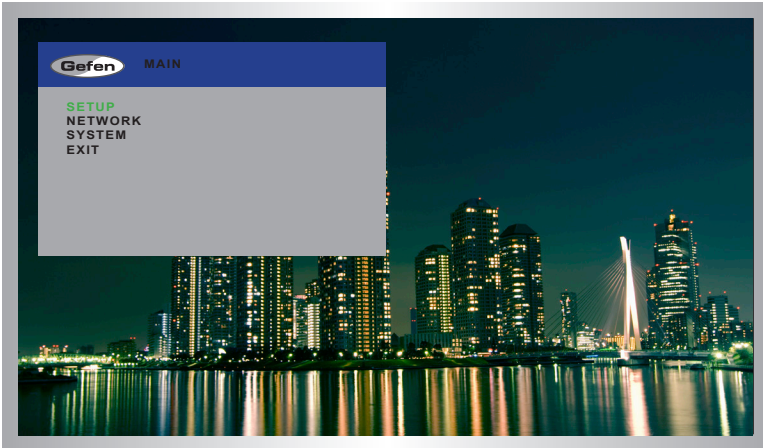

Using the IR Remote Control

The IR remote control has buttons which represent the controls on the front panel. Use the ◀, ▶, ▲, and ▼ buttons to move around within the menu system. Press the ▲ and ▼ buttons to move up and down. Press the ◀ or ▶ buttons to change the value of the current selection. Press the **OK** button to make the desired selection. The current selection will be highlighted in green.

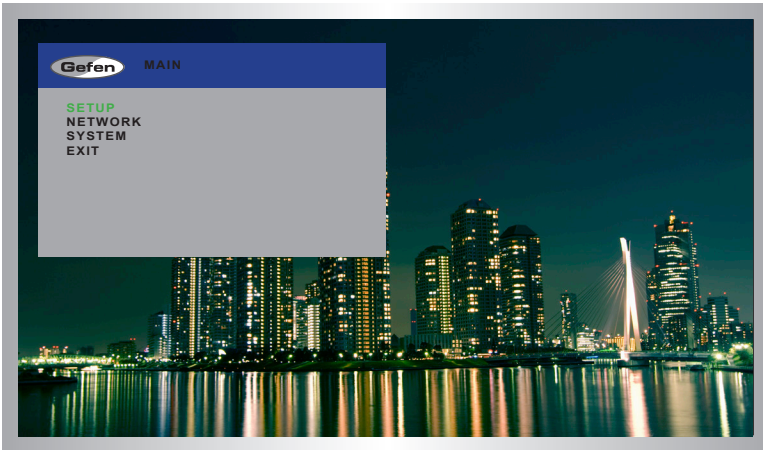

Press to select the highlighted menu item



Press the ▲ and ▼ buttons to move up and down within the menu system

Setting the Output Resolution



NOTE: Before changing this setting, make sure that all connected displays can support the selected output resolution.

1. Press the **Menu** button on the front panel or on the IR remote control. The menu system will be displayed.

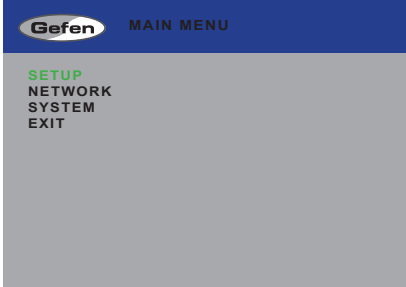

2. Press the **Select** button. If using the IR remote, press the **OK** button.

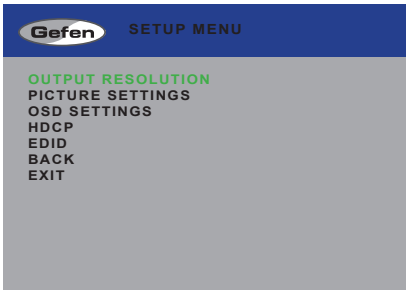

3. Press the **Select** button again to enter the **Output Resolution** menu. If using the IR remote, press the **OK** button.

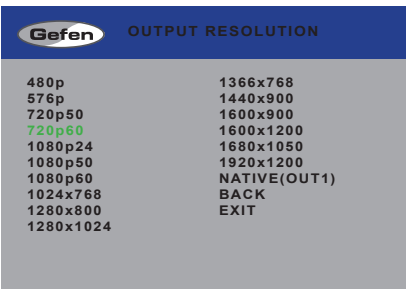



4. Use the ▲ or ▼ buttons to highlight the desired output resolution.
5. Press the **Select** button to apply the highlighted resolution. If using the IR remote, press the **OK** button.

If the display does not support the selected resolution, use the `#fadefault` command to reset the 4x4 Seamless Matrix for HDMI.

See [RS-232 and IP Configuration](#) for more information on configuring RS-232.

Adjusting the Contrast

1. Press the **Menu** button on the front panel or on the IR remote control. The menu system will be displayed.

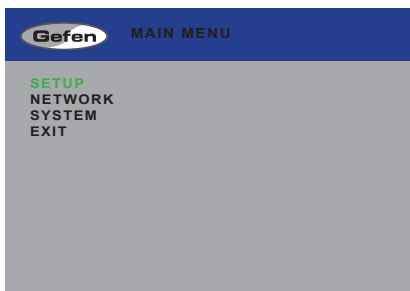

2. Press the **Select** button to display the **Setup Menu**. If using the IR remote, press the **OK** button.
3. Use the **▲** or **▼** buttons to highlight **Picture Settings**.

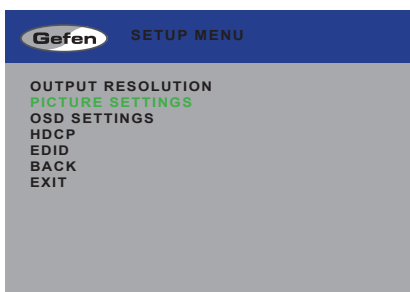

4. Press the **Select** button to display the **Picture Settings** menu. If using the IR remote, press the **OK** button.
5. The **Out Select** option should be highlighted. If not, use the **▲** or **▼** buttons to highlight it. Each output can have individual contrast settings. Therefore, the output must be selected before making changes to it.

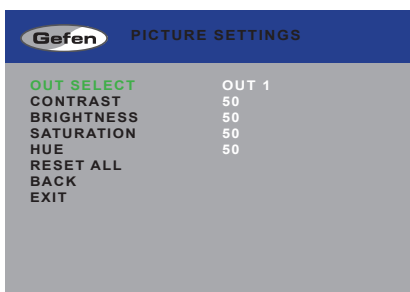

6. Press the **Select** button to select the **Out Select** option. The currently selected output will be highlighted in orange.
7. Select the desired output using the ◀ or ▶ buttons.

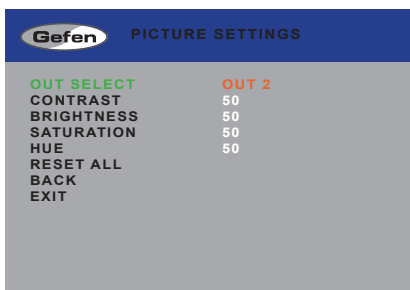

8. Press the **Select** button to accept the current output selection.
9. Use the ▲ or ▼ buttons to highlight the **Contrast** option.
10. Press the **Select** button to select the **Contrast** option.
11. Change the contrast value using the ◀ or ▶ buttons.

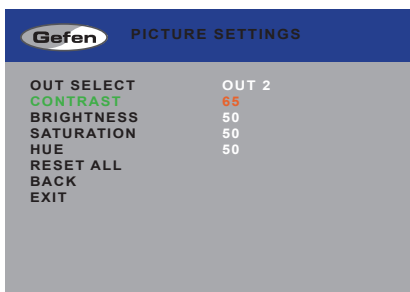

12. Press the **Select** button to accept the change.

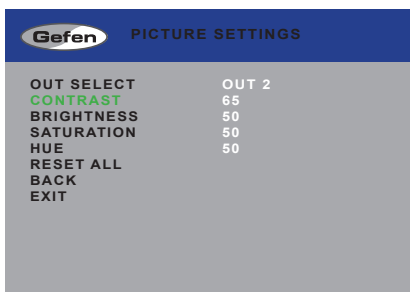

Adjusting the Brightness

1. Press the **Menu** button on the front panel or on the IR remote control. The menu system will be displayed.



2. Press the **Select** button to display the **Setup Menu**. If using the IR remote, press the **OK** button.
3. Use the **▲** or **▼** buttons to highlight **Picture Settings**.

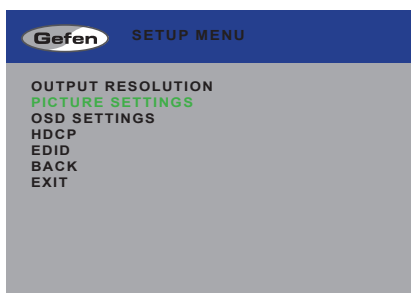

4. Press the **Select** button to display the **Picture Settings** menu. If using the IR remote, press the **OK** button.
5. The **Out Select** option should be highlighted. If not, use the **▲** or **▼** buttons to highlight it. Each output can have individual brightness settings. Therefore, the output must be selected before making changes to it.

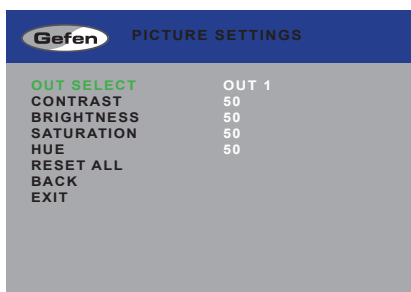

6. Press the **Select** button to select the **Out Select** option. The currently selected output will be highlighted in orange.
7. Select the desired output using the ◀ or ▶ buttons.

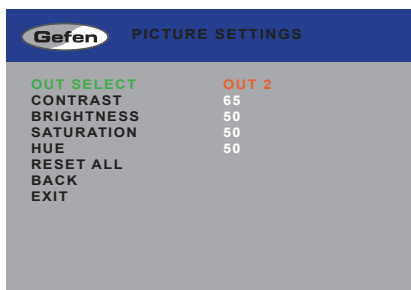

8. Press the **Select** button to accept the current output selection.
9. Use the ▲ or ▼ buttons to highlight the **Brightness** option.
10. Press the **Select** button to select the **Brightness** option.
11. Change the brightness value using the ◀ or ▶ buttons.

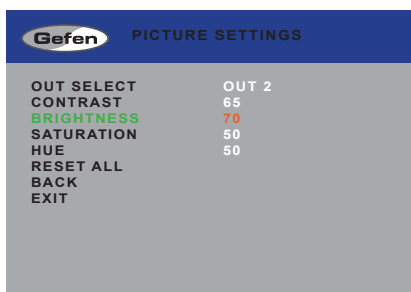

12. Press the **Select** button to accept the change.

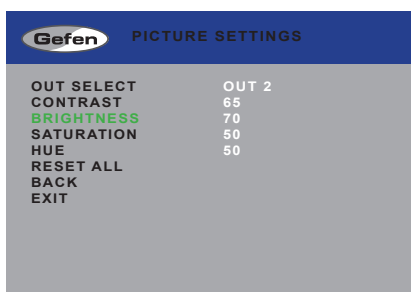

Adjusting the Saturation

1. Press the **Menu** button on the front panel or on the IR remote control. The menu system will be displayed.



2. Press the **Select** button to display the **Setup Menu**. If using the IR remote, press the **OK** button.
3. Use the **▲** or **▼** buttons to highlight **Picture Settings**.



4. Press the **Select** button to display the **Picture Settings** menu. If using the IR remote, press the **OK** button.
5. The **Out Select** option should be highlighted. If not, use the **▲** or **▼** buttons to highlight it. Each output can have individual saturation settings. Therefore, the output must be selected before making changes to it.

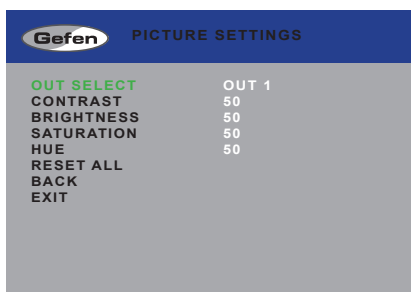

6. Press the **Select** button to select the **Out Select** option. The currently selected output will be highlighted in orange.
7. Select the desired output using the ◀ or ▶ buttons.

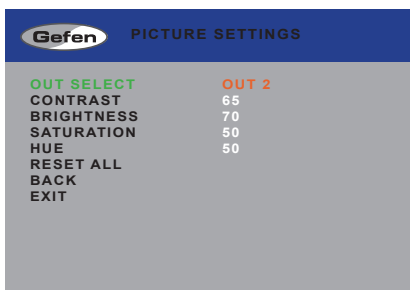

8. Press the **Select** button to accept the current output selection.
9. Use the ▲ or ▼ buttons to highlight the **Saturation** option.
10. Press the **Select** button to select the **Saturation** option.
11. Change the saturation value using the ◀ or ▶ buttons.

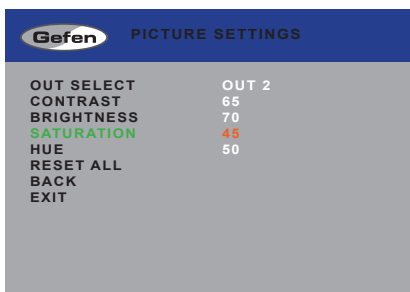

12. Press the **Select** button to accept the change.

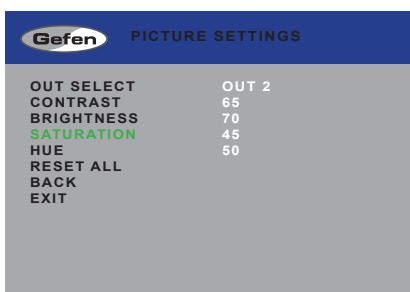

Adjusting the Hue

1. Press the **Menu** button on the front panel or on the IR remote control. The menu system will be displayed.



2. Press the **Select** button to display the **Setup Menu**. If using the IR remote, press the **OK** button.
3. Use the **▲** or **▼** buttons to highlight **Picture Settings**.

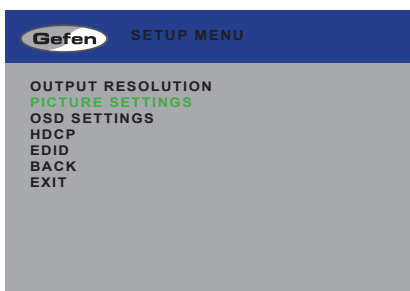

4. Press the **Select** button to display the **Picture Settings** menu. If using the IR remote, press the **OK** button.
5. The **Out Select** option should be highlighted. If not, use the **▲** or **▼** buttons to highlight it. Each output can have individual hue settings. Therefore, the output must be selected before making changes to it.

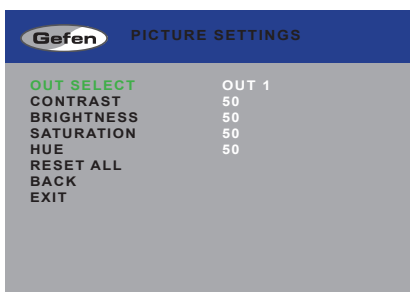

6. Press the **Select** button to select the **Out Select** option. The currently selected output will be highlighted in orange.
7. Select the desired output using the ◀ or ▶ buttons.

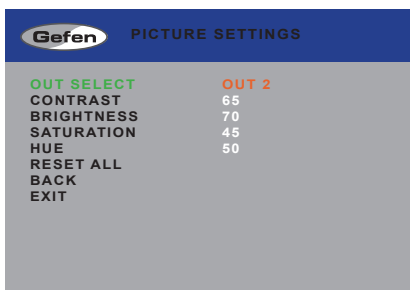

8. Press the **Select** button to accept the current output selection.
9. Use the ▲ or ▼ buttons to highlight the **Hue** option.
10. Press the **Select** button to select the **Hue** option.
11. Change the hue value using the ◀ or ▶ buttons.

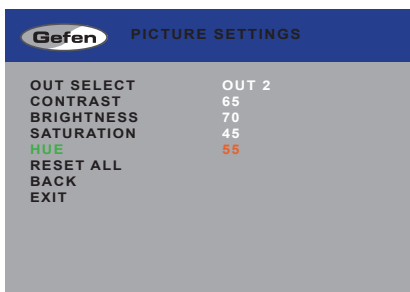

12. Press the **Select** button to accept the change.

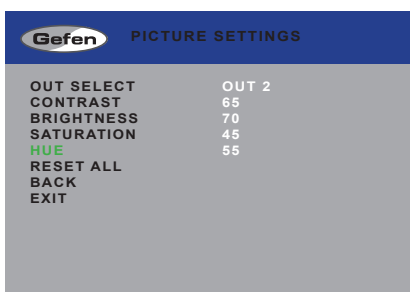

OSD Settings

The OSD Settings menu controls how the OSD is displayed.

1. Press the **Menu** button on the front panel or on the IR remote control. The menu system will be displayed.

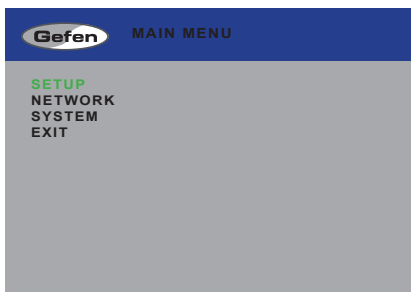

2. Press the **Select** button to display the **Setup Menu**. If using the IR remote, press the **OK** button.
3. Use the **▲** or **▼** buttons to highlight **OSD Settings**.

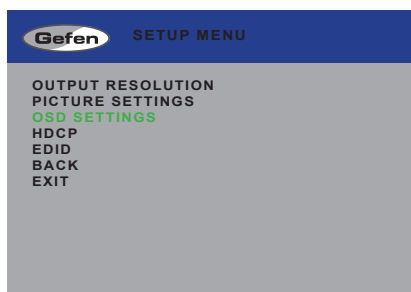

4. Press the **Select** button to display the **OSD Settings** menu.

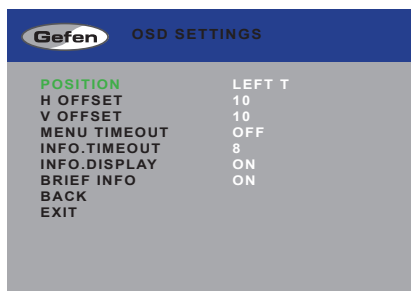

- Use the ▲ or ▼ buttons to highlight the option to change. The **Position** option will be highlighted, automatically.

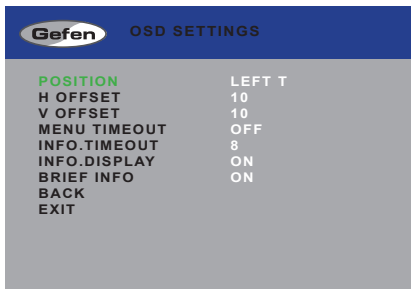

- Once the desired option is highlighted, press the **Select** button to select it. If using the IR remote control, press the **OK** button.

When an option is selected, its current value will be highlighted in orange. Use the ◀ or ▶ buttons to change the value.

Position

Assigns the display where the OSD will be displayed, when the Menu button is pressed.



H Offset

The horizontal offset of the OSD, as it appears on the display.



V Offset

The vertical offset of the OSD, as it appears on the display.

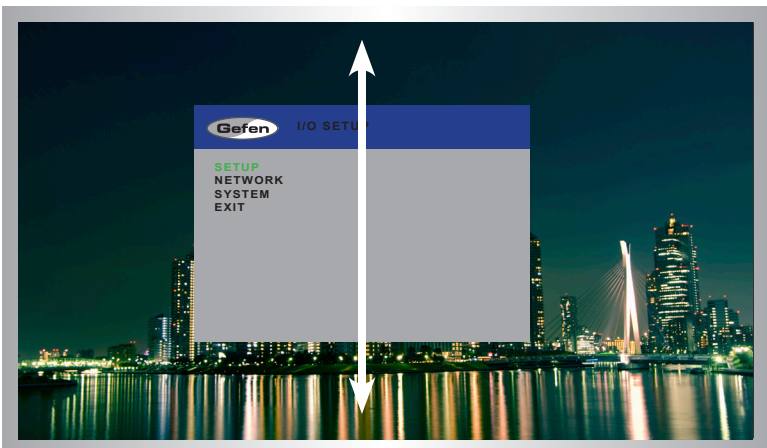

Menu Timeout

Once the **Menu** button is pressed, the OSD will appear. Menu Timeout is the duration, in seconds, of the OSD before it is automatically hidden. If set to **Off**, then the OSD must be hidden manually by pressing the **Menu** button.

Info Timeout

By default, each display will show an information (info) window. This window displays the input and output resolution. Menu Timeout is the duration, in seconds, of the OSD before it is automatically hidden.

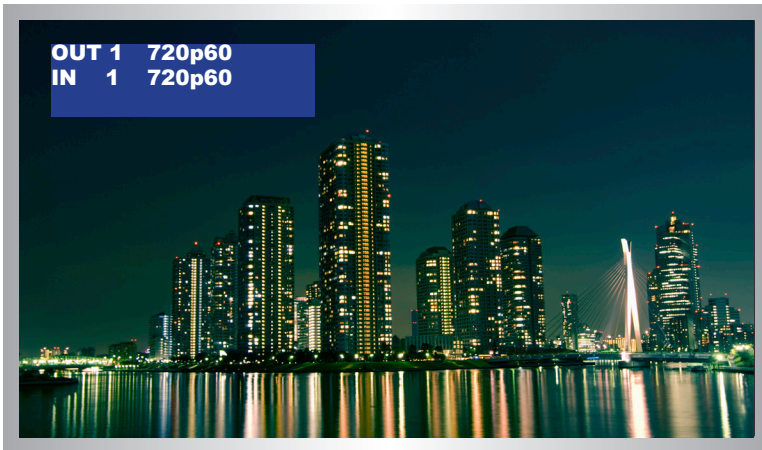

Info Display

Enables (**On**) or disables (**Off**) the Info window. If set to **Off**, the Info window is never displayed.

Brief Info

This option controls what is displayed when **Info Display** set to On. If **Brief Info** is set to **On**, then only the In and Out routing information is displayed. If **Brief Info** is set to **Off**, then the resolution information is also displayed.

HDCP

Some sources (e.g. computers) will enable HDCP if an HDCP-compliant display is detected. Inputs can be set to **accept** or **not accept** HDCP content. Outputs can be set to **follow** (pass-through) the input setting or **set to always on**.

1. Press the **Menu** button on the front panel or on the IR remote control. The menu system will be displayed.

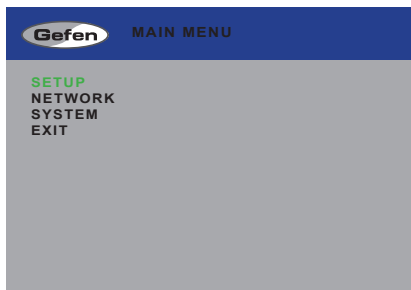

2. Press the **Select** button to display the **Setup Menu**. If using the IR remote, press the **OK** button.
3. Use the **▲** or **▼** buttons to highlight **HDCP**.

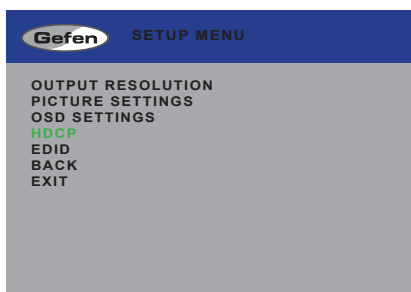

4. Press the **Select** button to display the **HDCP** menu.

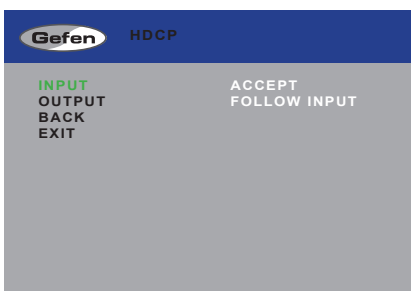

- Use the ▲ or ▼ buttons to highlight either the **Input** or **Output** option.
- Press the **Select** button to select the desired option. If using the IR remote, press the **OK** button.

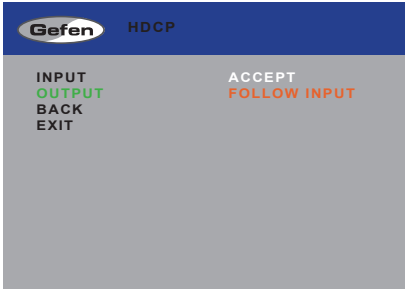

- Use the ◀ or ▶ buttons to change the value.

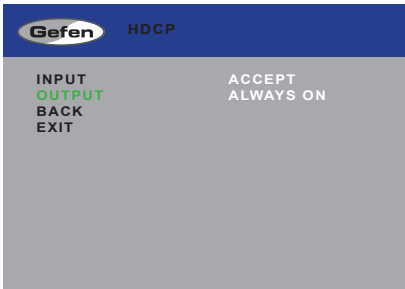

Input: Accept or Not Accept.

Use the Accept option to allow HDCP content to pass on the input.

Use the Not Accept option to prevent HDCP content from being transmitted to the input.

Output: Always On / Follow Input

Use the Always On option to allow HDCP to pass through on the output.

Use the Follow Input option to have the output follow the input setting (Accept / Not Accept).

- Press the **Select** button to accept the change. If using the IR remote, press the **OK** button.

EDID Management

1. Press the **Menu** button on the front panel or on the IR remote control. The menu system will be displayed.

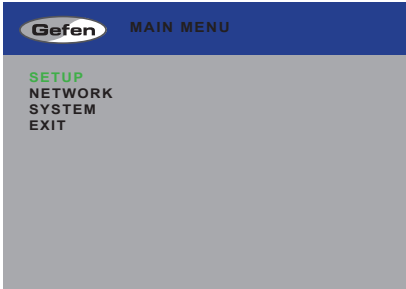

2. Press the **Select** button to display the **Setup** menu. If using the IR remote, press the **OK** button.
3. Use the **▲** or **▼** buttons to highlight the **EDID** option.

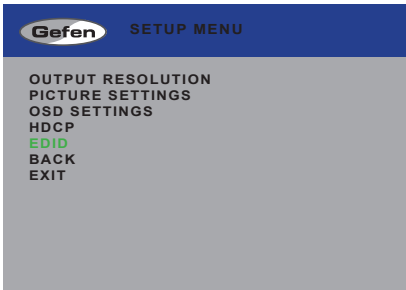

4. Press the **Select** button to display the **EDID** menu. If using the IR remote, press the **OK** button.

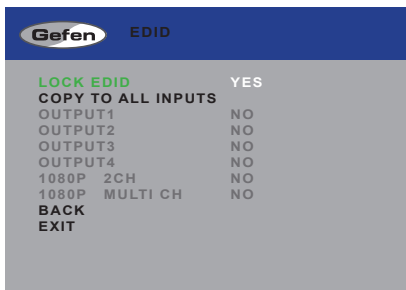

5. Press the **Select** button to select the **Lock EDID** option.
6. Use the ◀ or ▶ buttons to change the value of the **Lock EDID** option.
7. Press the **Select** button to accept the **Lock EDID** value.

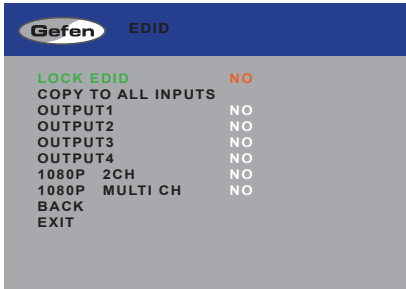

Selecting an EDID

1. Make sure the **Lock EDID** option is set to **No**.
2. Use the ▲ or ▼ buttons to highlight the desired output, containing the EDID to be copied to the input. The 1080p 2CH or 1080p Multi Ch EDID can also be selected.

When selecting an EDID, make sure that all displays can support the same audio and video capabilities

3. Press the **Select** button to accept the current selection. If using the IR remote, press the **OK** button.
4. Use the ◀ or ▶ buttons to select either **Yes** or **No**.
5. Press the **Select** button to save the changes. If using the IR remote, press the **OK** button.

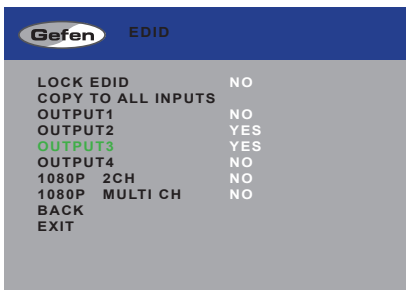

6. The display will flash momentarily. The EDID from the selected output will be copied to the input and will be used by all outputs.

Changing the IP Settings

1. Press the **Menu** button on the front panel or on the IR remote control. The menu system will be displayed.
2. Use the **▲** or **▼** buttons to highlight the **Network** option.



3. Press the **Select** button to display the **Network** menu. If using the IR remote, press the **OK** button.

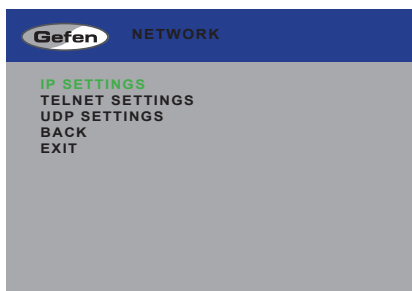

4. Press the **Enter** button again to display the **IP Settings** menu. If using the IR remote, press the **OK** button.

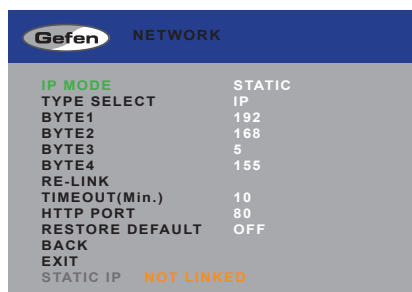

- Use the ▲ or ▼ buttons to highlight the option to change. The **IP Mode** option will be highlighted, automatically.
- Once the desired option is highlighted, press the **Select** button to select it. If using the IR remote control, press the **OK** button.

When an option is selected, its current value will be highlighted in orange.

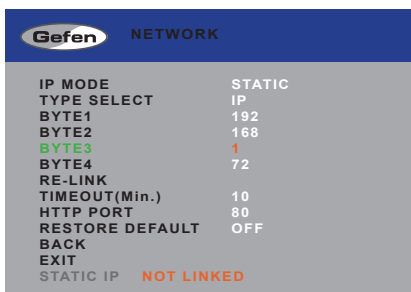

- Use the ◀ or ▶ buttons to change the current value.
- Press the **Select** button to accept the current changes. If using the IR remote control, press the **OK** button.

IP Mode

Set this option to either Static or DHCP. If using the Static option, the IP address must be specified. Use the Byte1, Byte2, Byte3, and Byte4 options to set each of the digits in the IP address, subnet mask, and gateway.

Type Select

Use this option to switch between the IP address (IP), subnet mask (Mask), and gateway (Gate).

Byte

Use the Byte1, Byte2, Byte3, and Byte4 options to set each of the digits in the IP address, subnet mask, and gateway.

Re-link

Use this option to attempt to re-link to the network using the current IP settings.

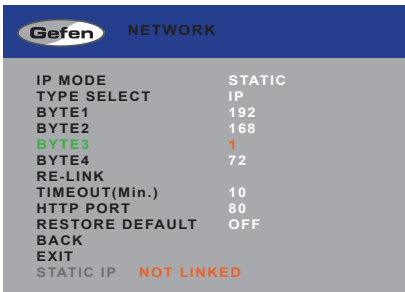

Gefen NETWORK	
IP MODE	STATIC
TYPE SELECT	IP
BYTE1	192
BYTE2	168
BYTE3	1
BYTE4	72
RE-LINK	
TIMEOUT(Min.)	10
HTTP PORT	80
RESTORE DEFAULT	OFF
BACK	
EXIT	
STATIC IP	NOT LINKED

Timeout

Sets the time-out period (in seconds) when using the Re-Link option to link with the network using the current IP settings.

HTTP Port

Sets the HTTP listening port for the 4x4 Seamless Matrix for HDMI.

Restore Default

This option will reset the default IP settings for the 4x4 Seamless Matrix for HDMI.

Changing the Telnet Settings

1. Press the **Menu** button on the front panel or on the IR remote control. The menu system will be displayed.
2. Use the **▲** or **▼** buttons to highlight the **Network** option.



3. Press the **Select** button to display the **Network** menu. If using the IR remote, press the **OK** button.
4. Use the **▲** or **▼** buttons to highlight the **Telnet Settings** option.

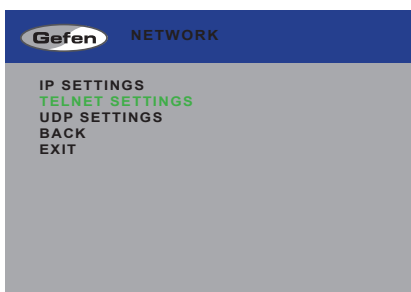

5. Press the **Select** button again to display the **Telnet Settings** menu. If using the IR remote, press the **OK** button.

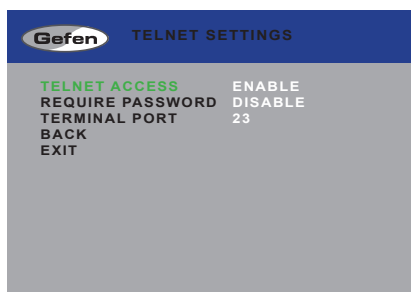

5. Use the ▲ or ▼ buttons to highlight the option to change. The **Telnet Access** option will be highlighted, automatically.
6. Once the desired option is highlighted, press the **Select** button to select it. If using the IR remote control, press the **OK** button.

When an option is selected, its current value will be highlighted in orange.

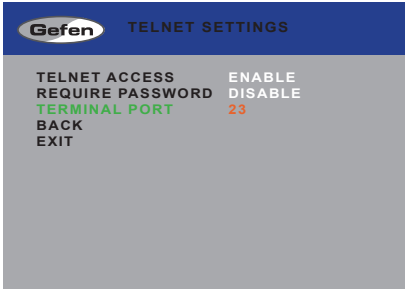

7. Use the ◀ or ▶ buttons to change the current value.
8. Press the **Select** button to accept the current changes. If using the IR remote control, press the **OK** button.

Telnet Access

Enables (On) or disables (Off) Telnet access for the HD Video Wall Controller.

Require Password

Enables or disables the password prompt at the beginning of a Telnet session.

Terminal Port

Sets the Telnet listening port for the 4x4 Seamless Matrix for HDMI.

Changing the UDP Settings

1. Press the **Menu** button on the front panel or on the IR remote control. The menu system will be displayed.
2. Use the **▲** or **▼** buttons to highlight the **Network** option.



3. Press the **Select** button to display the **Network** menu. If using the IR remote, press the **OK** button.
4. Use the **▲** or **▼** buttons to highlight the **UDP Settings** option.

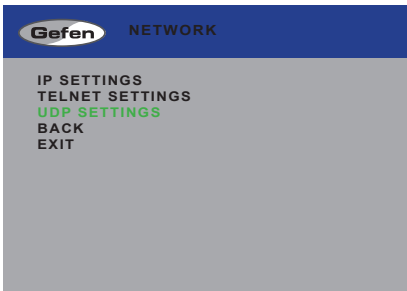

5. Press the **Select** button again to display the **UDP Settings** menu. If using the IR remote, press the **OK** button.

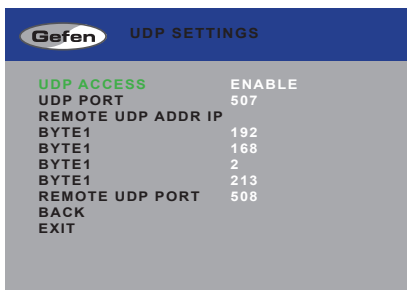

5. Use the ▲ or ▼ buttons to highlight the option to change. The **UDP Access** option will be highlighted, automatically.
6. Once the desired option is highlighted, press the **Select** button to select it. If using the IR remote control, press the **OK** button.

When an option is selected, its current value will be highlighted in orange.

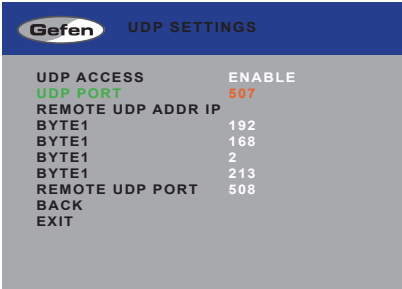

7. Use the ◀ or ▶ buttons to change the current value.
8. Press the **Select** button to accept the current changes. If using the IR remote control, press the **OK** button.

UDP Access

Enables or disables UDP access to the HD Video Wall Controller.

UDP Port

Sets the UDP port for the 4x4 Seamless Matrix for HDMI.

Byte

Use the Byte1, Byte2, Byte3, and Byte4 options to set the IP address of the digits in the UDP IP address, subnet mask, and gateway.

Remote UDP Port

Sets the remote UDP listening port for the 4x4 Seamless Matrix for HDMI.

System Settings

1. Press the **Menu** button on the front panel or on the IR remote control. The menu system will be displayed.
2. Use the ▲ or ▼ buttons to highlight the **System** option.

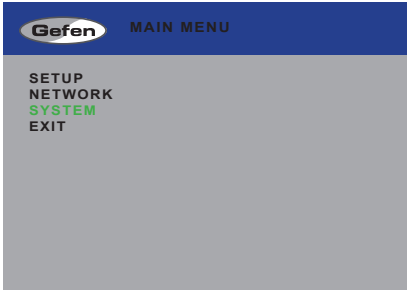

3. Press the **Select** button to display the **System** menu. If using the IR remote, press the **OK** button.

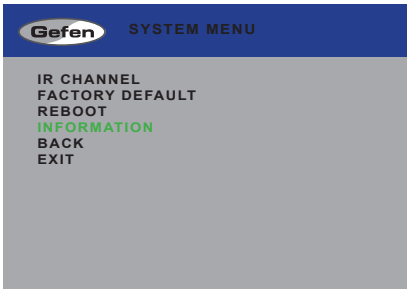

4. Use the ▲ or ▼ buttons to highlight the desired option.
5. Press the **Select** button to make the selection. If using the IR remote control, press the **OK** button.

4x4 Seamless Matrix for HDMI

03 Advanced Operation

RS-232 and IP Configuration	54
RS-232 Interface	54
RS-232 Settings	54
IP / UDP Configuration	55
Commands	56
Web Interface	112
Using the built-in Web Interface	112
Main ▶ Routing	113
Main ▶ I/O Status	117
Main ▶ Display Info	119
I/O Setup ▶ Preset Names	120
I/O Setup ▶ I/O Names	121
I/O Setup ▶ HPD Control	122
I/O Setup ▶ HDCP	123
I/O Setup ▶ Video	125
Manage EDID ▶ Assign	127
Manage EDID ▶ Bank Names	131
Manage EDID ▶ Upload / Download	132
Network	134
System	138

RS-232 and IP Configuration

RS-232 Interface

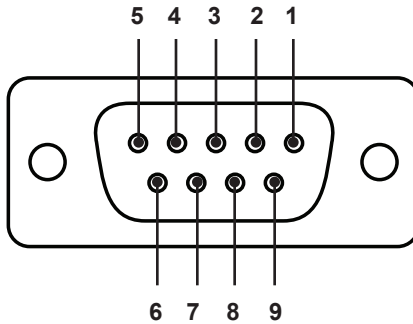

RS-232 Controller

Matrix

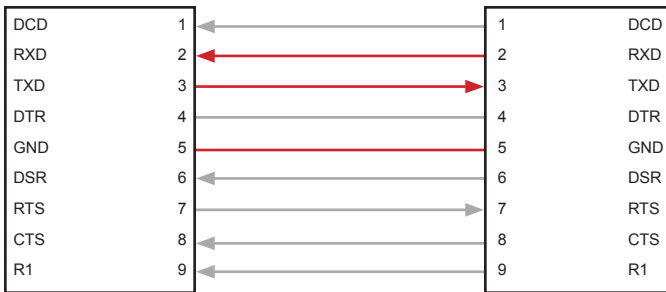

Only TXD, RXD, and GND pins are used.

RS-232 Settings

Description	Setting
Baud rate	19200
Data bits	8
Parity	None
Stop bits	1
Hardware flow control	None



IMPORTANT: When sending Telnet or RS-232 commands, a carriage return (0d) and a line feed (0a) must be included at the end of the command.

IP / UDP Configuration

The 4x4 Seamless Matrix for HDMI supports IP-based control using Telnet, UDP, or the built-in Web-based GUI. To set up IP control, the network settings for the 4x4 Seamless Matrix for HDMI must be configured via RS-232. The default network settings for the matrix are as follows:

Description	IP Address / Port	Description	IP Address / Port
IP Address	192.168.1.72	UDP Port	23
Subnet	255.255.255.0	Local UDP Port	50007
Gateway	192.168.1.254	Remote UDP IP	192.168.1.255
HTTP Port	80	Remote UDP Port	50008

1. Connect an RS-232 cable from the PC to the 4x4 Seamless Matrix for HDMI. Also make sure that an Ethernet cable is connected between the matrix and the network.
2. Launch a terminal emulation program (e.g. HyperTerminal) and use the RS-232 settings listed on the previous page.



NOTE: Depending upon the network, all related IP, Telnet, and UDP settings will need to be assigned. Consult your network administrator to obtain the proper settings.

3. Set the IP address for the matrix using the `#set_ipadd` command.
4. Set the subnet mask using the `#set_netmask` command.
5. Set the gateway (router) IP address using the `#set_gateway` command.
6. Set the Telnet listening port using the `#set_telnet_port` command.
7. Set the HTTP listening port using the `#set_http_port` command.
8. Set the UDP remote IP address for the matrix using the `#set_udp_remote_ip` command.
9. Set the UDP listening port for the matrix using the `#set_udp_port` command.
10. Set the UDP remote port for the matrix using the `#set_udp_remote_port` command.
11. Reboot the matrix to apply all changes, then type the IP address that was specified in step 3, in a Web browser to access the Web GUI. Use the same IP address to Telnet to the matrix.

Commands

Command	Description
#display_telnet_welcome	Enables / disables the Telnet welcome message
#fadefault	Resets the current routing and masking state to factory-default settings
#help	Displays the list of available commands
#hdp_pulse	Cycles with HPD line on the specified output
#lock_edid	Locks the local EDID when the matrix is power-cycled
#lock_matrix	Locks / unlocks the matrix
#mask	Masks the specified outputs
#mute	Enables / disables muting on all outputs
#power	Toggles the power on the matrix
#reboot	Reboots the matrix
#recall_preset	Loads the specified routing preset into memory
#save_preset	Saves a routing preset to memory
#set_bank_name	Assigns a name to the specified EDID bank
#set_brightness	Sets the brightness level for all outputs
#set_contrast	Sets the contrast level for all outputs
#set_edid	Assigns the specified EDID to an input or bank
#set_gateway	Sets the gateway address
#set_hdcp	Enables / disables HDCP detection
#set_http_port	Sets the HTTP listening port
#set_hue	Sets the hue for all outputs
#set_input_name	Assigns a name to the specified input
#set_ipadd	Sets the IP address
#set_ipmode	Sets the IP mode (DHCP or static)
#set_netmask	Sets the subnet mask
#set_output	Sets the output resolution
#set_output_name	Assigns a name to the specified output
#set_preset_name	Assigns a name to the specified preset
#set_saturation	Set the saturation for the specified output
#set_telnet_pass	Sets the Telnet password
#set_telnet_port	Sets the Telnet listening port
#set_udp_port	Sets the UDP serial port
#set_udp_remote_ip	Sets the remote UDP IP address
#set_udp_remote_port	Sets the remote UDP port
#set_webui_ad_pass	Sets the Administrator password
#set_webui_op_pass	Sets the Operator password

Command	Description
#show_bank_name	Displays the name for the specified EDID bank
#show_brightness	Displays the brightness value for all outputs
#show_contrast	Displays the contrast value for all outputs
#show_gateway	Displays the IP address of the (router) gateway
#show_hdcp	Displays the HDCP status of the specified input
#show_http_port	Displays the Web server listening port
#show_hue	Displays the hue value for all outputs
#show_ip	Displays the current IP address of the matrix
#show_ipconfig	Displays the current TCP/IP settings of the matrix
#show_ipmode	Displays the current IP mode (DHCP or static)
#show_mac_addr	Displays the MAC address of the matrix
#show_me	Enables or disables the flashing of the LED on the device
#show_netmask	Displays the current subnet mask
#show_output	Displays the output resolution
#show_power	Displays the power state of the matrix
#show_preset_name	Displays the name for the specified preset
#show_saturation	Displays the saturation value for all outputs
#show_telnet_port	Displays the current Telnet port
#show_udp_port	Displays the current UDP port
#show_udp_remote_ip	Displays the current UDP remote IP address
#show_udp_remote_port	Displays the current UDP remote port
#show_ver_data	Displays the current hardware and software version
#unmask	Disables masking on the specified output
#use_discovery	Enables or disables discovery mode
#use_tcp_access	Enable / disable Telnet access
#use_telnet_pass	Enable / disable login credentials for Telnet sessions
#use_udp_access	Enable / disable UDP access
m	Displays the matrix routing status
r	Routes the specified input to the output
s	Routes the specified input to all outputs

#display_telnet_welcome

The #display_telnet_welcome command enables / disables the Telnet welcome message during a Telnet session.

Syntax

```
#display_telnet_welcome param1
```

Parameters

param1 Value [0 ... 1]

Value	Description
0	Disable welcome message
1	Enable welcome message

Example

```
#display_telnet_welcome 1
TELNET WELCOME SCREEN IS ENABLED
```

When enabled and a Telnet session has been started, the following will appear:

```
Welcome to EXT-HD-SL-444 TELNET
```

#fadefault

The #fadefault command resets the matrix to factory-default settings. Outputs are unmasked and all IP and UDP settings are reset to default settings.

Syntax

```
#fadefault
```

Parameters

None

Example

```
#fadefault  
  
MATRIX WAS RESET TO FACTORY DEFAULTS  
IP: 192.168.5.155  
Netmask: 255.255.255.0  
Gateway: 192.168.5.254  
Warning : Ethernet Cable UnPlugged!!  
Ethernet Cable Plug in!!
```

#help

The #help command displays the list of available RS-232 / Telnet commands. Help on a specific command can be displayed when using `param1`.

Syntax

```
#help param1
```

Parameters

<i>param1</i>	Command name (optional)
---------------	-------------------------

Example

```
#help #sipadd
```

```
SET IP ADDRESS (FOR STATIC)  
CMD : #SET_IPADD PARAM1  
PARAM1 = ddd.ddd.ddd.ddd
```

#hdp_pulse

The #hdp_pulse command cycles the HPD line on the specified input. Issuing this command is identical to physically disconnecting and reconnecting the cable between the source and the matrix.

Syntax:

```
#hdp_pulse param1
```

Parameters:

<i>param1</i>	Input	[1 ... 4]
---------------	-------	-----------

Examples:

```
#hdp_pulse 1  
HPD PULSE HAS BEEN SENT TO INPUT1
```

#lock_edid

The #lock_edid command secures the Local EDID by disabling the automatic loading of the downstream EDID when the matrix is powered.

Syntax:

```
#lock_edid param1
```

Parameters:

param1 Value [0 ... 1]

Value	Description
0	Disable
1	Enable

Examples:

```
#lock_edid 0  
MATRIX EDID IS UNLOCKED
```

```
#lock_edid 1  
MATRIX EDID IS LOCKED
```

#lock_matrix

The #lock_matrix command locks / unlocks the matrix. When the matrix is locked, all functions are disabled including the front panel, RS-232, and Telnet.

Syntax

```
#lock_matrix param1
```

Parameters

param1

Value

[0 ... 1]

Value	Description
0	Unlock
1	Lock

Example

```
#lock_matrix 1  
MATRIX IS LOCKED
```

#mask

The `#mask` command masks the video on the specified output(s). Use the `#unmask` command to disable output masking. If `param1 = 0`, then all outputs are masked.

Syntax

```
#mask param1
```

Parameters

<i>param1</i>	Output	[0 ... 4]
---------------	--------	-----------

Examples

```
#mask 1  
OUTPUT A IS MASKED
```

```
#mask 0  
ALL OUTPUTS ARE MASKED
```

#mute

The #mute command enables / disables audio muting on all outputs.

Syntax

```
#mute param1
```

Parameters

param1

Value

[0 ... 1]

Value	Description
0	Unlock
1	Lock

Example

```
#mute 1  
AUDIO IS MUTED
```

#power

The `#power` command toggles power on the matrix.

Syntax

```
#power param1
```

Parameters

param1

Value

[0 ... 1]

Value	Description
0	Off
1	On

Examples

```
#power 0  
POWER IS OFF
```

```
#power 1  
POWER IS ON
```

#reboot

The `#reboot` command reboots the matrix. Executing this command is the equivalent of disconnecting and reconnecting the AC power cord, on the back of the matrix. The matrix must be rebooted after changing any of the IP settings.

Syntax

```
#reboot
```

Parameters

None

Example

```
#reboot
DEVICE HAS BEEN REBOOTED
IP: 192.168.5.155
Netmask: 255.255.255.0
Gateway: 192.168.5.254
Ethernet Cable Plug in!!
```

#recall_preset

The #recall_preset command loads the routing preset.

Syntax

```
#recall_preset param1
```

Parameters

<i>param1</i>	Preset	[1 ... 10]
---------------	--------	------------

Example

```
#recall_preset 2  
INPUT 4 IS ROUTED TO WINDOW OUTPUT 1  
RECALL ROUTING STATE PRESET 2
```

#save_preset

The #save_preset command saves the current routing state to a specified preset.

Syntax

```
#save_preset param1
```

Parameters

<i>param1</i>	Preset	[1 ... 10]
---------------	--------	------------

Example

```
#save_preset 1  
CURRENT ROUTING STATE IS SAVED TO PRESET 1
```

#set_bank_name

The #set_bank_name command names the specified bank.

Syntax

```
#set_bank_name param1 param2
```

Parameters

<i>param1</i>	Bank	[1 ... 8]
<i>param2</i>	Name	

Example

```
#set_bank_name 5 Dell_24  
BANK5 NAME IS ASSIGNED TO Dell24
```

#set_brightness

The #set_brightness command sets the brightness level of the video signal on all outputs.

Syntax

```
#set_brightness param1
```

Parameters

<i>param1</i>	Level	[0 ... 100]
---------------	-------	-------------

Examples

```
#set_brightness 65  
OUTPUT 1 IS SET TO BRIGHTNESS VALUE : 65
```

#set_contrast

The `#set_contrast` command sets the contrast level of the video signal on the specified output.

Syntax

```
#set_contrast param1 param2
```

Parameters

<i>param1</i>	Level	[0 ... 100]
---------------	-------	-------------

Examples

```
#set_contrast 74  
OUT A IS SET TO CONTRAST VALUE : 74
```

#set_edid

The #set_edid command sets the specified EDID type to an input or bank.

Syntax

```
#set_edid param1 param2 param3 param4
```

Parameters

param1 Source [STRING]

Source	Description
int	Uses default (Internal) EDID
bank	Uses EDID bank
output	Uses EDID on Output (sink)

param2 Source [1 ... 8]

Source	Description
1 ... 2	1 = 1080p / 2CH 2 = 1080p / Multichannel
1 ... 8	EDID bank
1 ... 4	Output

param3 Target [STRING]

Target	Description
input	Specifies an input
bank	Specifies an EDID bank

param4 Target [1 ... 8]

Value	Description
1 ... 4	Input
1 ... 8	EDID bank

(continued on next page)

Examples

```
#set_edid int 2 input 4  
INTERNAL EDID 2 IS SAVED TO INPUT4
```

```
#set_edid bank 3 bank 5  
BANK EDID 3 IS SAVED TO BANK5
```

#set_gateway

The `#set_gateway` command sets the gateway address. The gateway must be typed using dot-decimal notation. The matrix must be rebooted after executing this command. The default gateway is `192.168.1.1`.

Syntax

```
#set_gateway param1
```

Parameters

<i>param1</i>	Gateway
---------------	---------

Example

```
#set_gateway 192.168.1.5  
GATEWAY : 192.168.1.11
```

#set_hdcp

The #set_hdcp command sets the HDCP state for the inputs / outputs.

Syntax

```
#set_hdcp param1 param2 param3
```

Parameters

param1 Value [0 ... 1]

Value	Description
0	Input
1	Output

param2 Value [0 ... 4]

Value	Description
0	All
1	Input 1
2	Input 2
3	Input 3
4	Input 4

param3 Value [0 ... 1]

Value	Description
0	Accept / Follow Input
1	Not Accept / Always On

(continued on next page)

The meaning of *param3* changes depending upon the value specified by *param1*.

For example, if *param1* = 0, then the HDCP settings will affect the inputs.

Setting *param3* = 0 will result in setting the specified input to "Accept". If *param3* = 1, then the input will be set to "Not Accept"

Conversely, if *param1* = 1, then the HDCP settings will affect the outputs.

Setting *param3* = 0 will result in the affecting the outputs: If *param3* = 0, then the specified output will be set to "Follow Input". If *param3* = 1, then the specified input will be set to "Always On".

Examples

```
#set_hdcp 0 2 1  
HDCP INPUT2 IS SET TO NOT ACCEPT
```

```
#set_hdcp 1 1 0  
ALL HDCP OUTPUTS ARE SET TO FOLLOW INPUT
```

#set_http_port

The `#set_http_port` command specifies the Web server listening port. The matrix must be rebooted after executing this command. The default port setting is 80. Use the `#show_http_port` command to display the current HTTP listening port.

Syntax

```
#set_http_port param1
```

Parameters

<i>param1</i>	Port	[1 ... 1024]
---------------	------	--------------

Example

```
#set_http_port 82  
HTTP PORT 82 IS SET
```

#set_hue

The `#set_hue` command sets the hue for all outputs.

Syntax

```
#set_hue param1
```

Parameters

<i>param1</i>	Value	[0 ... 100]
---------------	-------	-------------

Example

```
#set_hue 30  
OUT A SET TO HUE VALUE : 30
```

#set_input_name

The #set_input_name command assigns a name to the specified input on the matrix.

Syntax

```
#set_input_name param1 param2
```

Parameters

<i>param1</i>	Input	[1 ... 4]
<i>param2</i>	Name	

Example

```
#set_input_name 3 Blu-ray  
INPUT3 NAME IS ASSIGNED TO Blu-ray
```

#set_ipadd

The #set_ipadd command sets the IP address of the matrix. The IP address must be entered using dot-decimal notation. The matrix must be rebooted after executing this command. The default IP address is 192.168.1.72. Use the #show_ipconfig command to display the current IP address of the matrix.

Syntax

```
#set_ipadd param1
```

Parameters

<i>param1</i>	IP address
---------------	------------

Example

```
#set_ipadd 192.168.1.190  
IP ADDRESS : 192.168.1.190
```

#set_ipmode

The `#set_ipmode` command sets the IP mode to DHCP or static. The matrix must be rebooted after executing this command. Use the `#show_ipmode` command to display the current IP mode.

Syntax

```
#set_ipmode param1
```

Parameters

param1 Value [0 ... 1]

Value	Description
0	Static
1	DHCP

Example

```
#set_ipmode 1  
IP MODE SET TO STATIC  
PLEASE REBOOT TO ACTIVATE!!!
```

#set_netmask

The `#set_netmask` command sets the subnet mask. The subnet mask must be entered using dot-decimal notation. The matrix must be rebooted after executing this command. The default subnet mask is 255.255.255.0. Use the `#show_netmask` or the `#show_ipconfig` command to display the current net mask of the matrix.

Syntax

```
#set_netmask param1
```

Parameters

<i>param1</i>	Subnet mask
---------------	-------------

Example

```
#set_netmask 255.255.255.0  
NETMASK : 255.255.255.0
```

#set_output

The `#set_output` command sets the output resolution. The specified output resolution is applied to all outputs. Use the `#show_output` command to display the current output resolution.

Syntax

```
#set_output param1
```

Parameters

param1 Value [0 ... 16]

Value	Description
0	480p
1	576p
2	720p @ 50 Hz
3	720p @ 60 Hz
4	1080p @ 24 Hz
5	1080p @ 50 Hz
6	1080p @ 60 Hz
7	1024 x 768
8	1280 x 800
9	1280 x 1024
10	1366 x 768
11	1440 x 900
12	1600 x 900
13	1600 x 1200
14	1680 x 1050
15	1920 x 1200
16	Native

Example

```
#set_output 3
OUTPUT RESOLUTION IS SET TO : 720p60
```

#set_output_name

The `#set_output_name` command assigns a name to the output on the matrix. The name of the output is limited to 15 characters. Names longer than 15 characters will be truncated.

Syntax

```
#set_output_name param1 param2
```

Parameters

<i>param1</i>	Output	[1 ... 4]
<i>param2</i>	Name	

Example

```
#set_output_name 3 Sony_XBR  
OUTPUT3 NAME IS ASSIGNED TO Sony_XBR
```

#set_preset_name

The `#set_preset_name` command assigns a name to the specified preset. The name of the preset is limited to 8 characters. Names longer than 8 characters will be truncated. To display the name of a preset, use the `#show_preset_name` command.

Syntax

```
#set_preset_name param1 param2
```

Parameters

<i>param1</i>	Preset	[1 ... 10]
<i>param2</i>	Name	

Example

```
#set_preset_name 4 BR2Out2  
PRESET4 NAME IS ASSIGNED TO BR2Out2
```

#set_saturation

The `#set_saturation` command sets the color saturation level for all outputs. Use the `#show_saturation` command to display the current saturation value.

Syntax

```
#set_saturation param1
```

Parameters

<i>param1</i>	Level	[0 ... 100]
---------------	-------	-------------

Example

```
#set_saturation 65  
OUT A SET TO SATURATION VALUE : 65
```

#set_telnet_pass

The `#set_telnet_pass` command sets the Telnet password. The password cannot exceed 10 characters in length.

Syntax

```
#set_telnet_pass param1
```

Parameters

<i>param1</i>	Password	[STRING]
---------------	----------	----------

Example

```
#set_telnet_pass bossman
```

#set_telnet_port

The `#set_telnet_port` command sets the Telnet listening port. The matrix must be rebooted after executing this command. The default port setting is 23. Use the `#show_telnet_port` command to display the current Telnet listening port.

Syntax

```
#set_telnet_port param1
```

Parameters

<i>param1</i>	Port	[1 ... 1024]
---------------	------	--------------

Example

```
#set_telnet_port 24  
TELNET PORT 24 IS SET
```

#set_udp_port

The `#set_udp_port` command sets the UDP communication port.
Use the `#show_udp_port` command to display the current UDP communication port.

Syntax

```
#set_udp_port param1
```

Parameters

<i>param1</i>	Port	[1 ... 1024]
---------------	------	--------------

Example

```
#set_udp_port 1002
```

#set_udp_remote_ip

The `#set_udp_remote_ip` command sets the remote UDP IP address. The IP address must be specified using dot-decimal notation. The default UDP remote IP address is 192.168.1.255. The matrix must be rebooted after executing this command. Use the `#show_udp_remote_ip` command to display the current remote UDP IP address.

Syntax

```
#set_udp_remote_ip param1
```

Parameters

<i>param1</i>	UDP address
---------------	-------------

Example

```
#set_udp_remote_ip 192.168.1.227
UDP REMOTE IP ADDRESS : 192.168.1.227
```

#set_udp_remote_port

The `#set_udp_remote_port` command sets the remote UDP listening port. The default remote UDP listening port is 50008. The matrix must be rebooted after executing this command. Use the `#show_udp_remote_port` command to display the current remote UDP IP address.

Syntax

```
#set_udp_remote_port param1
```

Parameters

<i>param1</i>	Port	[0 ... 65535]
---------------	------	---------------

Example

```
#set_udp_remote_port 50008
```

```
REMOTE UDP COMMUNICATION PORT 50008 IS SET.
```

#set_webui_ad_pass

The #set_webui_ad_pass command sets the Administrator password for the Web GUI. The password is case-sensitive and cannot exceed 8 characters in length. The default password is Admin.

Syntax

```
#set_webui_ad_pass param1
```

Parameters

<i>param1</i>	Password
---------------	----------

Example

```
#set_webui_ad_pass bossman  
WEB UI ADMINISTRATOR PASSWORD IS SET bossman
```

#set_webui_op_pass

The `#set_webui_ad_pass` command sets the Operator password for the Web GUI. The default password is Admin.

Syntax

```
#set_webui_op_pass param1
```

Parameters

<i>param1</i>	Password
---------------	----------

Example

```
#set_webui_op_pass minion
WEB UI OPERATOR PASSWORD IS SET minion
```

#show_bank_name

The `#show_bank_name` command displays the name for the specified EDID bank. To name an EDID bank, use the `#set_bank_name` command.

Syntax

```
#show_bank_name param1
```

Parameters

<i>param1</i>	Bank	[1 ... 8]
---------------	------	-----------

Example

```
#show_bank_name 5
THE NAME FOR BANK5 IS : Dell24
```

#show_brightness

The `#show_brightness` command displays the brightness level for all outputs. Use the `#set_brightness` command to set the brightness value.

Syntax

```
#show_brightness
```

Parameters

None

Example

```
#show_brightness  
OUT A BRIGHTNESS VALUE : 65
```

#show_contrast

The `#show_contrast` command displays the contrast level for all outputs. Use the `#set_contrast` command to set the contrast value.

Syntax

```
#show_contrast
```

Parameters

None

Example

```
#show_contrast  
OUT A CONTRAST VALUE : 74
```

#show_gateway

The #show_gateway command displays the current gateway address of the matrix. Use the #set_gateway command to set the gateway address.

Syntax:

```
#show_gateway
```

Parameters:

None

Example:

```
#show_gateway  
GATEWAY : 192.168.1.11
```

#show_hdcp

The #show_hdcp command displays the current HDCP setting for inputs or outputs. Use the #set_hdcp command to set the HDCP input and output states.

Syntax

```
#show_hdcp param1
```

Parameters

param1 Value [0 ... 1]

Value	Description
0	Query input signal
1	Query output signal

Examples

```
#show_hdcp 0  
HDCP INPUT IS SET TO ACCEPT
```

```
#show_hdcp 1  
HDCP OUTPUT IS SET TO FOLLOW INPUT
```

#show_http_port

The #show_http_port command displays the current HTTP listening port of the matrix. Use the #set_http_port command to set the HTTP listening port. Use the #set_http_port command to set the HTTP listening port.

Syntax

```
#show_http_port
```

Parameters

None

Examples

```
#show_http_port  
HTTP PORT IS 80
```

#show_hue

The #show_hue command displays the current hue setting for all outputs. Use the #set_hue command to set the hue value.

Syntax

```
#show_hue
```

Parameters

<i>param1</i>	Output
---------------	--------

Example

```
#show_hue  
OUT A HUE VALUE : 30
```

#show_ip

The #show_ip command displays the current IP address of the matrix. Use the #set_ipadd command to set the IP address of the matrix.

Syntax

```
#show_ip
```

Parameters

None

Example

```
#show_ip  
IP ADDRESS : 192.168.1.190
```

#show_ipconfig

The #show_ipconfig command displays the current TCP/IP settings.

Syntax

```
#show_ipconfig
```

Parameters

None

Example

```
#show_ipconfig
IP CONFIGURATION IS:
(STATIC)
    IP : 192.168.1.190
NETMASK : 255.255.255.0
GATEWAY : 192.168.1.11
MAC ADDRESS = 00:1c:91:03:b0:00
```

#show_ipmode

The #show_ipmode command displays the current IP mode. Use the #set_ipmode command to set the IP mode.

Syntax

```
#show_ipmode
```

Parameters

None

Example

```
#show_ipmode
IP MODE SET TO STATIC
```

#show_mac_addr

The #show_mac_addr command displays the MAC address of the matrix.

Syntax

```
#show_mac_addr
```

Parameters

None

Example

```
#show_mac_addr  
MAC ADDRESS IS 00:1c:91:03:b0:00
```

#show_me

The #show_me command enables or disables the flashing of the LED on the device. When enabled, the LED indicator will flash red and blue. The default setting is *disabled*.

Syntax

```
#show_me param1
```

Parameters

param1 Value [0 ... 1]

Value	Description
0	Disabled
1	Enabled

Examples

```
#show_me 1  
SHOWME IS ON
```

#show_netmask

The `#show_netmask` command displays the current net mask of the 4x4 Seamless Matrix for HDMI. Use the `#set_netmask` command to set the net mask.

Syntax

```
#show_netmask
```

Parameters

None

Example

```
#show_netmask  
NETMASK : 255.255.255.0
```

#show_output

The `#show_output` command displays the current output resolution. Use the `#set_output` command to set the output resolution.

Syntax

```
#show_output
```

Parameters

None

Example

```
#show_output  
OUTPUT RESOLUTION IS SET TO : 720p60
```

#show_power

The #show_power command displays the current power state. Use the #power command to power-ON or power-OFF the matrix.

Syntax

```
#show_power
```

Parameters

None

Example

```
#show_power  
POWER IS ON
```

#show_preset_name

The `#show_preset_name` command displays the name for the specified preset. To assign a name to a preset, use the `#set_preset_name` command.

Syntax

```
#show_preset_name param1
```

Parameters

<i>param1</i>	Preset	[1 ... 10]
---------------	--------	------------

Example

```
#show_preset_name 4  
THE NAME FOR PRESET4 IS : BR2_Out2
```

#show_saturation

The `#show_saturation` command displays the saturation for all outputs. Use the `#set_saturation` command to set the output resolution.

Syntax

```
#show_saturation
```

Parameters

None

Example

```
#show_saturation  
OUT A SATURATION VALUE : 65
```

#show_telnet_port

The #show_telnet_port command displays the current Telnet port. Use the #set_telnet_port command to set the Telnet port.

Syntax

```
#show_telnet_port
```

Parameters

None

Example

```
#show_telnet_port  
TELNET PORT IS 23
```

#show_udp_port

The #show_udp_port command displays the current UDP serial port. Use the #set_udp_port command to set the UDP serial port.

Syntax:

```
#show_udp_serport
```

Parameters:

None

Example:

```
#show_udp_serport  
UDP SERVER PORT IS 1002
```

#show_udp_remote_ip

The #show_udp_remote_ip command displays the current remote UDP IP address. Use the #set_udp_remote_ip command to set the remote UDP IP address.

Syntax

```
#show_udp_remote_port
```

Parameters

None

Example

```
#show_udp_remote_port  
REMOTE UDP COMMUNICATION PORT IS: 508
```

#show_udp_remote_port

The #show_udp_remote_port command displays the current remote UDP port. Use the #set_udp_remote_port command to set the remote UDP port.

Syntax

```
#show_udp_remote_port
```

Parameters

None

Example

```
#show_udp_remote_port  
REMOTE UDP COMMUNICATION PORT IS: 508
```

#show_ver_data

The #show_ver_data command displays the current software and hardware version.

Syntax

```
#show_ver_data
```

Parameters

None

Example

```
#show_ver_data  
VERSION : SW[V2.11] / HW[V2.1]
```

#unmask

The #unmask command unmask the specified output(s). Use the #mask command to mask the specified output(s). If *param1* = 0, then all outputs are unmasked.

Syntax

```
#unmask param1
```

Parameters

<i>param1</i>	Output	[0 ... 4]
---------------	--------	-----------

Example

```
#unmask 2  
OUTPUT 2 IS UNMASKED
```

#use_discovery

The `#use_tcp_access` command enables or disables discovery access mode. If this mode is disabled, then the 4x4 Seamless Matrix for HDMI will not be discoverable when using the Gefen Syner-G Software Suite. The default setting is *enabled*.

Syntax

```
#use_discovery param1
```

Parameters

param1 Value [0 ... 1]

Value	Description
0	Discovery access disabled
1	Discovery access enabled

Example

```
#use_discovery 1  
DISCOVERY PROTOCOL IS ENABLED
```

#use_tcp_access

The #use_tcp_access command enables or disables Telnet access.

Syntax

```
#use_tcp_access param1
```

Parameters

param1 Value [0 ... 1]

Value	Description
0	Disable Telnet access
1	Enable Telnet access

Example

```
#use_tcp_access 1  
TELNET ACCESS IS ENABLED
```

#use_telnet_pass

The `#use_telnet_pass` command forces the password credentials for each Telnet session. The default setting is 0 (disabled). Use the `#set_telnet_pass` command to set the Telnet password.

Syntax

```
#use_telnet_pass param1
```

Parameters

param1 Value [0 ... 1]

Value	Description
0	Disable password
1	Enable password

Example

```
#use_telnet_pass 1  
TELNET INTERFACE PASSWORD IS DISABLED
```

#use_udp_access

The #use_udp_access command enables or disables UDP access.

Syntax

```
#use_udp_access param1
```

Parameters

param1 Value [0 ... 1]

Value	Description
0	Disable UDP access
1	Enable UDP access

Example

```
#use_udp_access 1
UDP ACCESS IS ENABLED
```

m

The `m` command displays the current routing status of the matrix. Masking and locking status of the matrix is also provided. Do not precede the `m` command with the `#` symbol.

Syntax

```
m
```

Parameters

None

Example

```
m
```

```
Show the matrix status in tabular form
```

```
Routing status table
```

```
Outputs | +0 | +1 | +2 | +3
```

```
1      | 1  | 2  | 3  | 4
```

```
Masking status table
```

```
Outputs | +0 | +1 | +2 | +3
```

```
1      | A  | A  | A  | A
```

```
Monitor HPD status table
```

```
Outputs | +0 | +1 | +2 | +3
```

```
1      | L  | L  | L  | L
```

```
RMT_IR - SW1=0,SW2=0
```

r

The `r` command routes the specified input to the output. Do not precede this command with the “#” symbol. Also see the `s` command. If `param2 = 0`, then the specified input (`param1`) will be routed to all outputs.

Syntax

```
r param1 param2
```

Parameters

<i>param1</i>	Input	[1 ... 4]
<i>param2</i>	Output	[0, 1 ... 4]

Examples

```
r 3 1  
INPUT 3 IS ROUTED TO WINDOW OUTPUT 1
```

```
r 1 0  
INPUT 1 IS ROUTED TO ALL WINDOW OUTPUTS
```

S

The `s` command routes the specified input to all outputs. Do not precede this command with the “#” symbol. Also see the `r` command.

Syntax

```
s param1
```

Parameters

<i>param1</i>	Input	[1 ... 4]
---------------	-------	-----------

Example

```
s 1  
INPUT 1 IS ROUTED TO ALL WINDOW OUTPUTS
```

Web Interface

Using the built-in Web Interface

Access the built-in Web interface by entering the IP address of the matrix that was specified in step 3 under [IP / UDP Configuration](#). Once connected to the matrix, the login screen will be displayed.

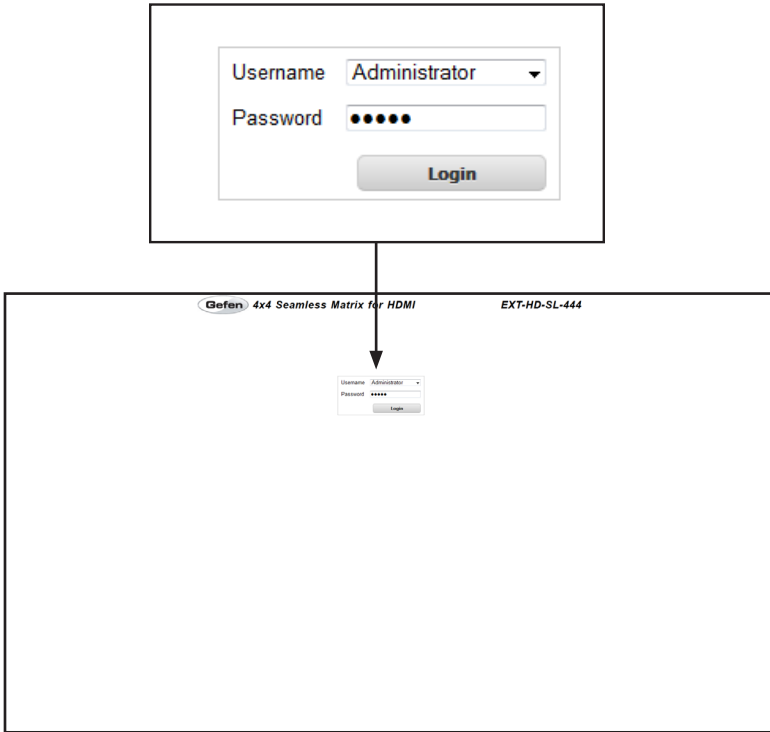

Username

Select the username from the drop-down list.

Options:

Operator, Administrator

Administrator login provides unrestricted access to all features and settings. Operator login limits access to matrix routing, display information, and routing preset features.

Password

Enter the password for the associated username. The password can also be set using RS-232 or Telnet. See the `#set_webui_ad_pass` and the `#set_webui_op_pass` commands. The password is masked when it is entered.

The Web GUI is divided into four main pages: **Main**, **I/O Setup**, **Manage EDID**, and **Configuration**. Each main page is represented by a tab at the top-most portion of the screen. The **Main**, **I/O Setup**, and **Manage EDID** pages have their own set of sub-tabs. Click on the desired tab / sub-tab to open the desired page.



NOTE: In order to view all four tabs at the top of the screen, the user must be logged in as “Administrator”. If logged-in as “Operator”, only the **Main** tab will be visible.

Main Routing

Power **STANDBY** **? Help** [Log Out](#)

The screenshot shows the web interface for the Gefen 4x4 Seamless Matrix for HDMI. The interface includes a navigation bar with tabs for Main, I/O Setup, Manage EDID, Network, and System. Below the navigation bar, there are buttons for Power (STANDBY), ? Help, and Log Out. The main content area displays a table of outputs and inputs, and a section for Save & Recall Routing Presets.

Outputs		Inputs		Status	
Name	Output	Input	Name	Output	Input #
Output_1	1	<input type="checkbox"/>	Input_1	1	4
Output_2	2	<input type="checkbox"/>	Input_2	2	1
Output_3	3	<input type="checkbox"/>	Input_3	3	2
Output_4	4	<input type="checkbox"/>	Input_4	4	3
			Master/Slave		

Save & Recall Routing Presets

Save Routing Preset:

Recall Routing Preset:

- Preset_1
- Preset_2
- Preset_3
- Preset_4
- Preset_5
- Preset_6
- Preset_7
- Preset_8
- Preset_9
- Preset_10

Power

Click this button to toggle the power state of the matrix. When the matrix is powered-on, the button will read “STANDBY”.

? Help

Click the “? Help” button to display context-sensitive help. This button is available on all main pages.

Log Out

Click **Log Out** to terminate the current Web session and return to the login page.

Name (Outputs)

The name of the output. The name of the output can also be changed using the `#set_output_name` command or through the **I/O Setup** ► **I/O Names** page of the Web interface.

Output (Outputs)

Check to select the desired output for routing.

Input # (Inputs)

Click the radio button next to the desired input to be routed.

Name (Inputs)

The name of the input. This name can be changed using the `#set_input_name` command or through the **I/O Setup** ► **I/O Names** page of the Web interface.

Output (Status)

The outputs that are available for routing.

Input # (Status)

The input that is currently routed to the output.

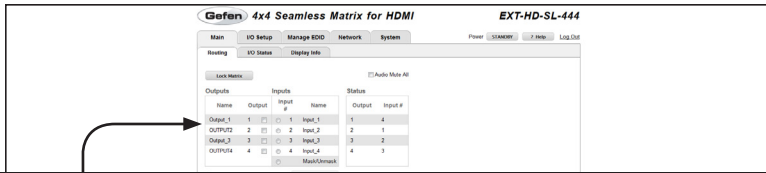

Outputs		Inputs		Status	
Name	Output	Input #	Name	Output	Input #
Output_1	1 <input type="checkbox"/>	<input type="radio"/> 1	Input_1	1	4
OUTPUT2	2 <input type="checkbox"/>	<input type="radio"/> 2	Input_2	2	1
Output_3	3 <input type="checkbox"/>	<input type="radio"/> 3	Input_3	3	2
OUTPUT4	4 <input type="checkbox"/>	<input type="radio"/> 4	Input_4	4	3
		<input type="radio"/>	Mask/Unmask		

Select All Outputs Route

Select All Outputs

Place a check mark in this box to select all outputs.

Route

Click the **Route** button to route the selected input to the select output(s).

Lock Matrix

Locks / unlocks the matrix. Once the matrix is locked, settings cannot be changed using the front-panel buttons or through the Web GUI. When the matrix is locked, the button text will read “Unlock Matrix” and a red bar will appear across the top portion of the screen with the text “Matrix is LOCKED”. Click the “Unlock Matrix” button to unlock the matrix.

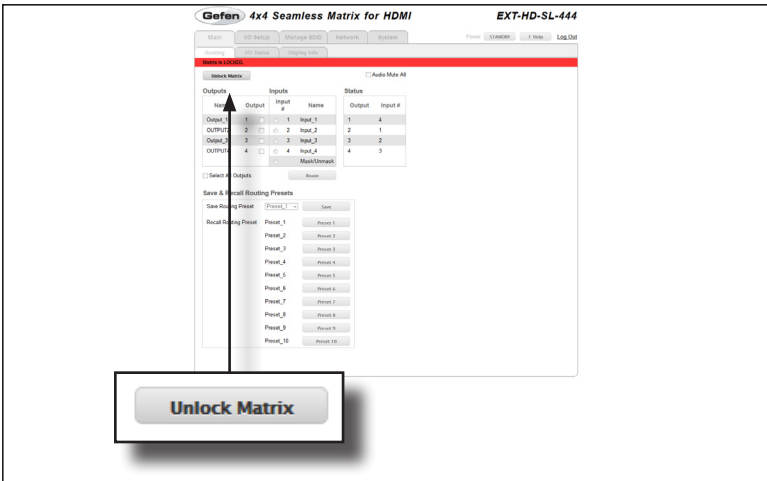
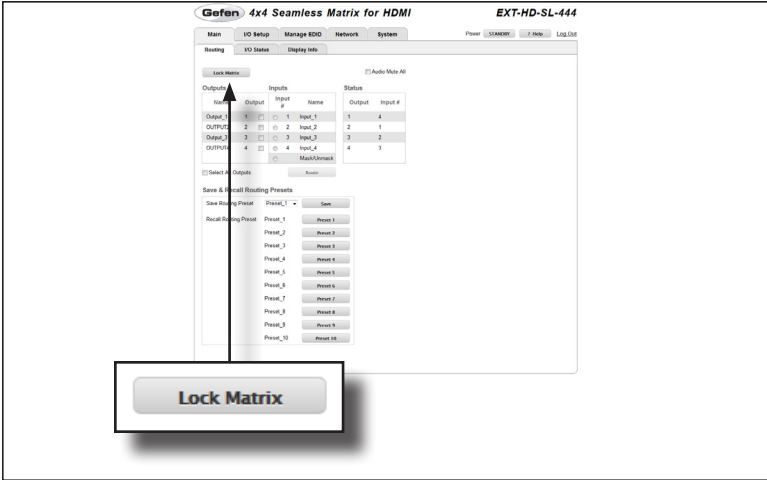

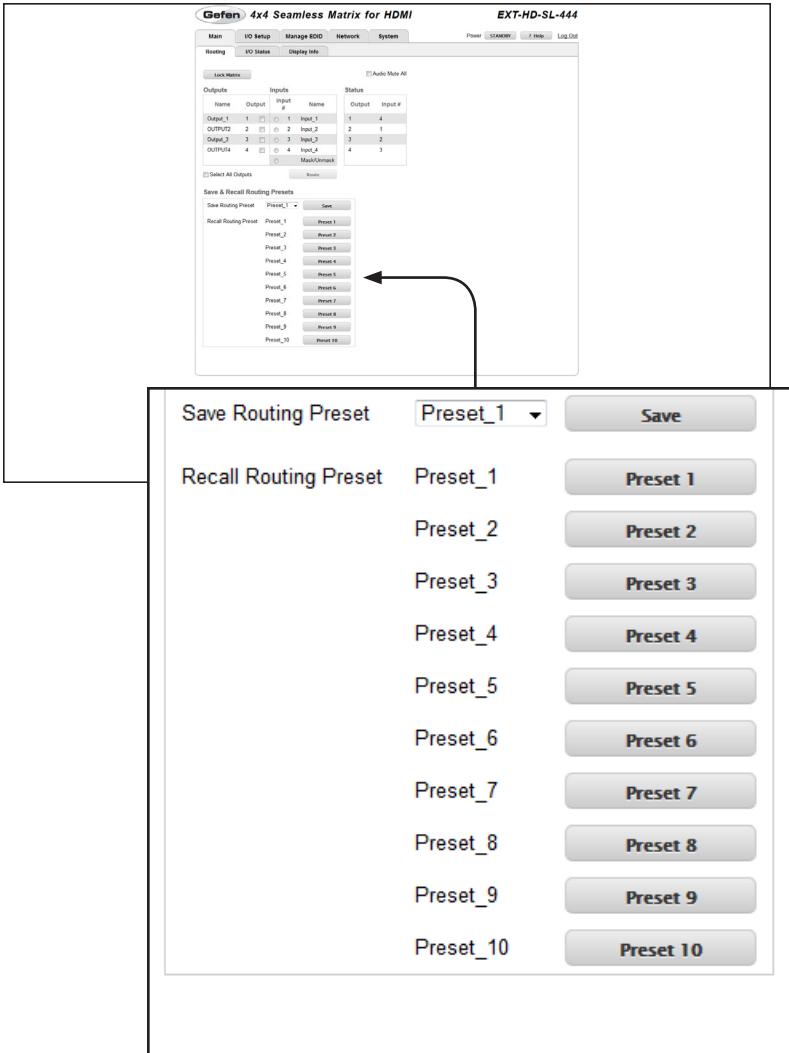

Save Routing Preset

Saves the current routing state to memory. Click the drop-down list to select the desired routing preset. Click the **Save** button to save the preset to memory.

Recall Routing Preset

Loads the selected routing state into memory. Click the desired Preset button to load a routing preset.

Main ► I/O Status

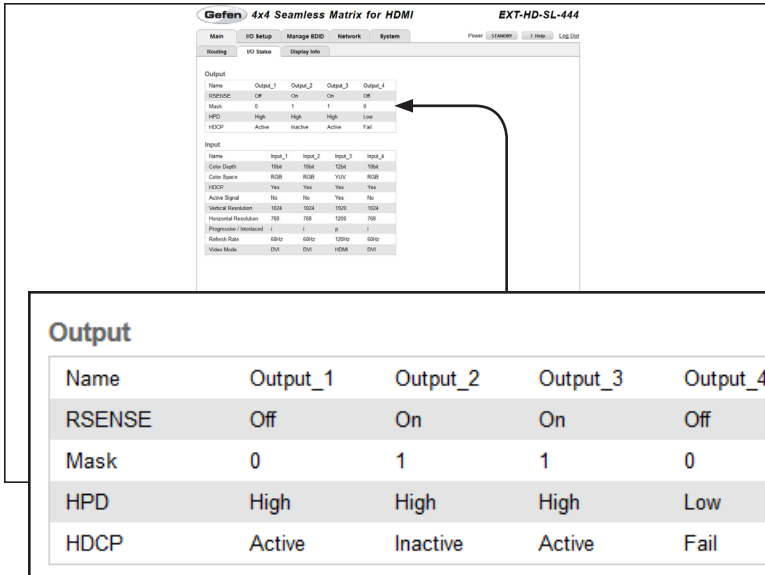

The screenshot shows the web interface for the Gefen 4x4 Seamless Matrix for HDMI (EXT-HD-SL-444). The 'I/O Status' page is active, displaying a table of output settings. A callout box highlights the 'Output' table.

Name	Output_1	Output_2	Output_3	Output_4
RSENSE	Off	On	On	Off
Mask	0	1	1	0
HPD	High	High	High	Low
HDCP	Active	Inactive	Active	Fail

Name

Displays the name of the output. The name of the output can be changed using the `#set_output_name` command or through the [I/O Setup ► I/O Names](#) page of the Web interface.

RSENSE

Displays the current Rsense state.

Mask

Displays the masking state of each output.

HPD

Displays the Hot-Plug Detect (HPD) state of each output.

HDCP

Indicates if HDCP-detection is enabled or disabled on each output.

Gefen 4x4 Seamless Matrix for HDMI EXT-HD-SL-444

Main I/O Setup Manage HDCP Network System Power STANDBY Z.MEM Log Out

Routing I/O Name Display Info

Output

Name	Output_1	Output_2	Output_3	Output_4
EDID	On	On	On	On
Mask	0	1	1	0
HSI	High	High	High	Low
HDCP	Active	Inactive	Active	Fail

Input

Name	Input_1	Input_2	Input_3	Input_4
Color Depth	10bit	10bit	12bit	10bit
Color Space	RGB	RGB	YUV	RGB
HDCP	Yes	Yes	Yes	Yes
Active Signal	No	No	Yes	No
Vertical Resolution	1024	1024	1920	1024
Horizontal Resolution	768	768	1200	768
Progressive / Interlaced	i	i	p	i
Refresh Rate	60Hz	60Hz	120Hz	60Hz
Video Mode	DVI	DVI	HDMI	DVI

Input

Name	Input_1	Input_2	Input_3	Input_4
Color Depth	10bit	10bit	12bit	10bit
Color Space	RGB	RGB	YUV	RGB
HDCP	Yes	Yes	Yes	Yes
Active Signal	No	No	Yes	No
Vertical Resolution	1024	1024	1920	1024
Horizontal Resolution	768	768	1200	768
Progressive / Interlaced	i	i	p	i
Refresh Rate	60Hz	60Hz	120Hz	60Hz
Video Mode	DVI	DVI	HDMI	DVI

Name

Displays the name of the input. The name of the input can be changed using the `#set_input_name` command or through the **I/O Setup ▶ I/O Names** page of the Web interface.

Color Depth

The color depth of the source signal.

Color Space

The color space of the source signal.

Vertical Resolution

The vertical resolution of the source signal.

Progressive / Interlaced

The field order of the input signal.

Refresh Rate

The refresh rate of the input signal.

HDCP

The HDCP state of the source signal.

Active Signal

Indicates if there is a source connected to the input.

Horizontal Resolution

The horizontal resolution of the source signal.

Video Mode

The video mode (HDMI / DVI) of the input.

Main ► Display Info

The screenshot shows the web interface for the Gefen 4x4 Seamless Matrix for HDMI (EXT-HD-SL-444). The 'Display Info' page is active, showing a table of features and audio formats. A callout box highlights the 'Info Display' checkbox, the 'Choose EDID' dropdown menu, and the 'Feature' table.

Info Display

Choose EDID: xBank 1

Feature

24Hz Frame Rate	Data
Max Resolution	returned
Max Color Depth	from
Mode (DVI/HDMI)	unit
Max Audio Channels	Yes
Monitor Name	No

Info Display

Place a check mark in this box to show display information on the outputs.

Choose EDID

Select the EDID from the drop-down list. The selected EDID will be copied from the Output or selected EDID Bank to the desired input(s) and used by the source.

Options
Bank 1 ... Bank 8
1 - Output_1 ... 4 - Output_4

Feature / Audio Formats

Displays the capabilities of the display (or sink device), based on the EDID.

I/O Setup ► Preset Names

The screenshot shows the 'Edit Preset Names' dialog box in the Gefen 4x4 Seamless Matrix for HDMI web interface. The dialog box contains a table with 10 rows, each representing a preset. The columns are 'Preset #' and 'Name'. The names are 'Preset_1' through 'Preset_10'. Below the table are 'Save' and 'Cancel' buttons. An arrow points from the 'Edit Preset Names' dialog box to the 'Edit Preset Names' section in the main interface.

Preset #	Name
1	Preset_1
2	Preset_2
3	Preset_3
4	Preset_4
5	Preset_5
6	Preset_6
7	Preset_7
8	Preset_8
9	Preset_9
10	Preset_10

Save Cancel

Preset #

The number of each preset.

Name

Type the desired name of each preset in these fields.

Save

Saves the current changes to the name of the preset(s).

Cancel

Restores the previous name or each preset, if the name was edited.

I/O Setup ► I/O Names

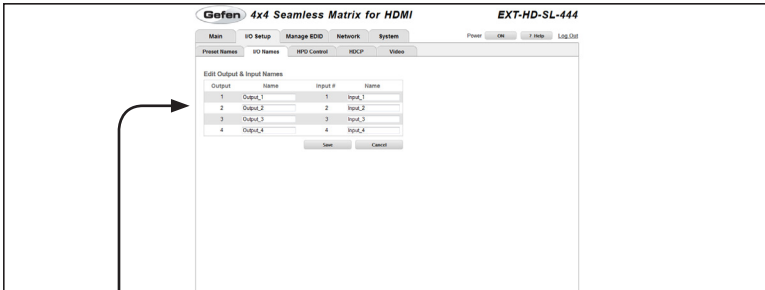

Edit Output & Input Names

Output	Name	Input #	Name
1	<input type="text" value="Output_1"/>	1	<input type="text" value="Input_1"/>
2	<input type="text" value="Output_2"/>	2	<input type="text" value="Input_2"/>
3	<input type="text" value="Output_3"/>	3	<input type="text" value="Input_3"/>
4	<input type="text" value="Output_4"/>	4	<input type="text" value="Input_4"/>

Output

The ID of the output.

Name (Output)

Type the desired name of each output in these fields.

Input #

The number of each input.

Name (Input #)

Type the desired name of each the input in these fields.

Save

Saves the current changes to the name of the output and/or input(s).

Cancel

Restores the previous name or each input / output, if the name was edited.

I/O Setup ► HPD Control

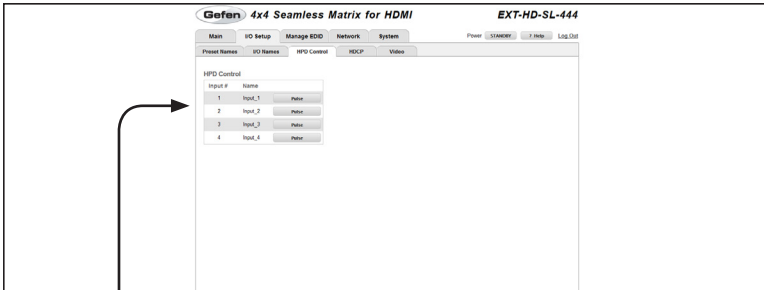

HPD Control

Input #	Name	
1	Input_1	<input type="button" value="Pulse"/>
2	Input_2	<input type="button" value="Pulse"/>
3	Input_3	<input type="button" value="Pulse"/>
4	Input_4	<input type="button" value="Pulse"/>

Input #

The number of the input.

Name

The name of the input. The name of each input can be changed using the `#set_input_name` command or through the [I/O Setup ► I/O Names](#) page of the Web interface.

Pulse

Click the Pulse button to cycle the HPD line on the desired input. This is the equivalent of physically disconnecting and reconnecting the HDMI cable between the source device and the matrix.

I/O Setup ► HDCP



NOTE: Some sources (e.g. computers) will enable HDCP if an HDCP-compliant display is detected. Check the box under the Disable column to force the computer to ignore detection of an HDCP-compliant display. The Disable feature does not decrypt HDCP content.

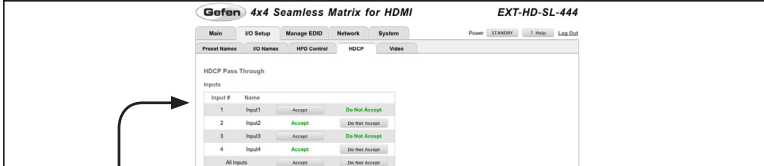

HDCP Pass Through

Inputs

Input #	Name	Accept	Do Not Accept
1	Input1	Accept	Do Not Accept
2	Input2	Accept	Do Not Accept
3	Input3	Accept	Do Not Accept
4	Input4	Accept	Do Not Accept
All Inputs		Accept	Do Not Accept

Input #

The number of the input.

Name

The name of the input. The name of each input can be changed using the `#set_input_name` command or through the [I/O Setup ► I/O Names](#) page of the Web interface.

Accept / Not Accept

Click the Accept button to allow HDCP content to pass on the input. Click the Do Not Accept button to prevent HDCP content from being transmitted to the input.

To change all inputs to “Accept” at once, click the Accept button in the row labeled “All Inputs”.

To change all outputs to “Do Not Accept” at once, click the Do Not Accept button in the row labeled “All Inputs”.

Output #	Name		
1	Output1	Always On	Follow Input
2	Output2	Always On	Follow Input
3	Output3	Always On	Follow Input
4	Output4	Always On	Follow Input
All Outputs		Always On	Follow Input

Always On / Follow Input

Click the Always On button to allow HDCP to pass through on the output. Click the Follow Input button to have the output follow the input setting (Accept / Not Accept). See the previous page for details.

To change all outputs to "Always On" at once, click the Always On button in the row labeled "All Outputs".

To change all outputs to "Follow Input" at once, click the Follow Input button in the row labeled "All Outputs".

I/O Setup ► Video

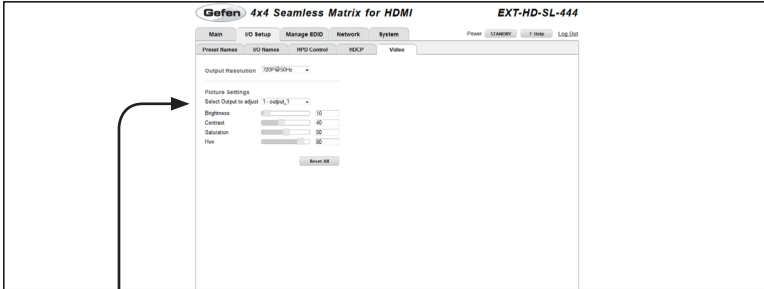

Output Resolution 720P@50Hz ▼

Picture Settings

Select Output to adjust 1 - output_1 ▼

Brightness 10

Contrast 40

Saturation 50

Hue 80

Reset All

Output Resolution

Select the desired output resolution from the drop-down list.

Options	
480p	1280 x 1024
576p	1366 x 768
720p @ 50 Hz	1440 x 900
720p @ 60 Hz	1600 x 900
1080p @ 24 Hz	1600 x 1200
1080p @ 50 Hz	1680 x 1050
1080p @ 60 Hz	1920 x 1200
1024 x 768	Native
1280 x 800	

Output Resolution 720P@50Hz ▾

Picture Settings

Select Output to adjust 1 - output_1 ▾

Brightness 10

Contrast 40

Saturation 50

Hue 80

Reset All

Select Output to adjust

Select the desired output from the drop-down list.

Brightness

Use the slider control to adjust the brightness of the output. The brightness value can also be entered directly in the value field.

Contrast

Use the slider control to adjust the contrast of the output. The contrast value can also be entered directly in the value field.

Saturation

Use the slider control to adjust the saturation of the output. The saturation value can also be entered directly in the value field.

Hue

Use the slider control to adjust the hue. The hue value can also be entered directly in the value field.

Reset All

Click this button to reset values to factory default settings.

Manage EDID ▶ Assign

Lock EDID

Secures the Local EDID and disables automatic EDID loading during power-up.

If the **Lock EDID** button is clicked (enabled), the “EDID locked on power cycle” message will be displayed in red. The local EDID information will now be locked once the matrix is rebooted. Click the **Unlock EDID** button to disable the Lock EDID feature.

Lock EDID

EDID locked on power cycle.

Gefen 4x4 Seamless Matrix for HDMI
EXT-HD-SL-444

Main IO Setup Manage EDID Network System
Power (STATUS) 7 MIN Log Out

Assign
Bank Names
Upload/Download

Lock EDID

Copy EDID From: Bank 1

Copy EDID To - Please select from the inputs below

Inputs

Copy To	EDID Modes	Input #	Name	EDID Source	EDID Name
<input type="checkbox"/>	Internal - 1000p 2 ch audio	1	Input 1	Test 1	GEFEN_HPT_SL
<input type="checkbox"/>	Internal - 1000p Multi ch	2	Input 2	Test 2	GEFEN_HPT_SL
<input type="checkbox"/>	Internal - 1000p Multi ch	3	Input 3	Test 3	GEFEN_HPT_SL
<input type="checkbox"/>	Internal - 1000p 2 ch audio	4	Input 4	Test 4	GEFEN_HPT_SL

Select All Inputs

Copy To	Bank #	Name	EDID Name
<input type="checkbox"/>	1	Bank 1	GEFEN_HPT_SL
<input type="checkbox"/>	2	Bank 2	GEFEN_HPT_SL
<input type="checkbox"/>	3	Bank 3	GEFEN_HPT_SL
<input type="checkbox"/>	4	Bank 4	GEFEN_HPT_SL
<input type="checkbox"/>	5	Bank 5	GEFEN_HPT_SL
<input type="checkbox"/>	6	Bank 6	GEFEN_HPT_SL
<input type="checkbox"/>	7	Bank 7	GEFEN_HPT_SL
<input type="checkbox"/>	8	Bank 8	GEFEN_HPT_SL

Select All Banks
Copy Cancel

Copy EDID From

Bank 1

Copy EDID To - Please select from the inputs below

Copy EDID From

Select the EDID from the drop-down list. The EDID will be copied from the Output or selected EDID bank to the destination

Options

Bank 1 ... Bank 8

Output 1 ... Output 4

Inputs

Copy To	EDID Modes
<input type="checkbox"/>	Internal - 720p 2 ch audio
<input type="checkbox"/>	Internal - 720p Multi ch
<input type="checkbox"/>	Internal - 720p Multi ch
<input type="checkbox"/>	Internal - 720p 2 ch audio

Select All Inputs

Copy To
Place a check mark in the desired check box to select or deselect the desired input(s).

Copy EDID To: Please select from the inputs below

Copy To	EDID Mode	Input #	Input Name	EDID Name	EDID Name
<input type="checkbox"/>	Internal - 1080p 2 ch audio	1	Input 1	Test 1	GEFEH_MPT_SL
<input type="checkbox"/>	Internal - 1080p Multi ch	2	Input 2	Test 2	GEFEH_MPT_SL
<input type="checkbox"/>	Internal - 1080p Multi ch	3	Input 3	Test 3	GEFEH_MPT_SL
<input type="checkbox"/>	Internal - 1080p 2 ch audio	4	Input 4	Test 4	GEFEH_MPT_SL

Select All Inputs

Copy To	Bank #	Bank Name	EDID Name
<input type="checkbox"/>	1	Bank 1	GEFEH_MPT_SL
<input type="checkbox"/>	2	Bank 2	GEFEH_MPT_SL
<input type="checkbox"/>	3	Bank 3	GEFEH_MPT_SL
<input type="checkbox"/>	4	Bank 4	GEFEH_MPT_SL
<input type="checkbox"/>	5	Bank 5	GEFEH_MPT_SL
<input type="checkbox"/>	6	Bank 6	GEFEH_MPT_SL
<input type="checkbox"/>	7	Bank 7	GEFEH_MPT_SL
<input type="checkbox"/>	8	Bank 8	GEFEH_MPT_SL

Select All Banks

Copy Cancel

EDID Modes

Select the EDID mode from the drop-down list.

Options
Internal - 1080p 2 ch audio
Internal - 1080p Multi ch
External - Output 1
Custom - User

Select All Inputs

Place a check mark in this check box to select all inputs. Remove the check mark to deselect all inputs.

Input #	Name	EDID Source	EDID Name
1	Input 1	Test 1	GEFEN_XPT_SL
2	Input 2	Test 2	GEFEN_XPT_SL
3	Input 3	Test 3	GEFEN_XPT_SL
4	Input 4	Test 4	GEFEN_XPT_SL

Copy EDID To: Please select from the inputs below

Inputs

Copy To	EDID Source	input #	name	EDID Source	EDID Name
<input type="checkbox"/>	Internal: 100% 2 in audio	1	Input 1	Test 1	GEFEN_XPT_SL
<input type="checkbox"/>	Internal: 100% Multi ch	2	Input 2	Test 2	GEFEN_XPT_SL
<input type="checkbox"/>	Internal: 100% Multi ch	3	Input 3	Test 3	GEFEN_XPT_SL
<input type="checkbox"/>	Internal: 100% 2 in audio	4	Input 4	Test 4	GEFEN_XPT_SL

Select All Inputs

Banks

Copy To	Bank #	Name	EDID Name
<input type="checkbox"/>	1	Bank 1	GEFEN_XPT_SL
<input type="checkbox"/>	2	Bank 2	GEFEN_XPT_SL
<input type="checkbox"/>	3	Bank 3	GEFEN_XPT_SL
<input type="checkbox"/>	4	Bank 4	GEFEN_XPT_SL
<input type="checkbox"/>	5	Bank 5	GEFEN_XPT_SL
<input type="checkbox"/>	6	Bank 6	GEFEN_XPT_SL
<input type="checkbox"/>	7	Bank 7	GEFEN_XPT_SL
<input type="checkbox"/>	8	Bank 8	GEFEN_XPT_SL

Select All Banks

Input #

The number of the input.

Name

The name of the input. The name of the input can be changed using the `#set_input_name` command or through the I/O Setup ► I/O Names page of the Web interface.

EDID Source

The current EDID source being used.

EDID Name

The name of the EDID.

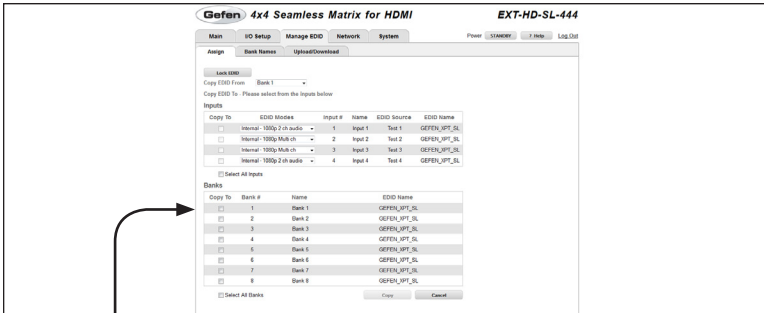

Copy To	Bank #	Name	EDID Name
<input type="checkbox"/>	1	Bank 1	GEFEN_XPT_SL
<input type="checkbox"/>	2	Bank 2	GEFEN_XPT_SL
<input type="checkbox"/>	3	Bank 3	GEFEN_XPT_SL
<input type="checkbox"/>	4	Bank 4	GEFEN_XPT_SL
<input type="checkbox"/>	5	Bank 5	GEFEN_XPT_SL
<input type="checkbox"/>	6	Bank 6	GEFEN_XPT_SL
<input type="checkbox"/>	7	Bank 7	GEFEN_XPT_SL
<input type="checkbox"/>	8	Bank 8	GEFEN_XPT_SL

Select All Banks

Copy Cancel

Copy To

Place a check mark in the desired check box to select the desired bank where the EDID will be copied. Remove the check mark to deselect the bank.

Bank

The number of the bank.

Name

The name of the bank.

Select All Banks

Place a check mark in this check box to select all banks. Remove the check mark to deselect all banks.

Copy

Press this button to execute the copy operation.

Cancel

Clears all check marks from each box.

Manage EDID ► Bank Names

The screenshot shows the 'Gefen 4x4 Seamless Matrix for HDMI' web interface. The 'Manage EDID' tab is active, and the 'Edit Bank Names' dialog box is open. The dialog box contains a table with the following data:

Bank #	Name
1	Bank 1
2	Bank 2
3	Bank 3
4	Bank 4
5	Bank 5
6	Bank 6
7	Bank 7
8	Bank 8

Below the table are 'Save' and 'Cancel' buttons.

Bank

Indicates the EDID bank number.

Name

Type the desired name of the EDID bank in this field.

Save

Saves the current name change to the EDID bank(s).

Cancel

Restores the previous name or each bank, if the name was edited.

Manage EDID ► Upload / Download

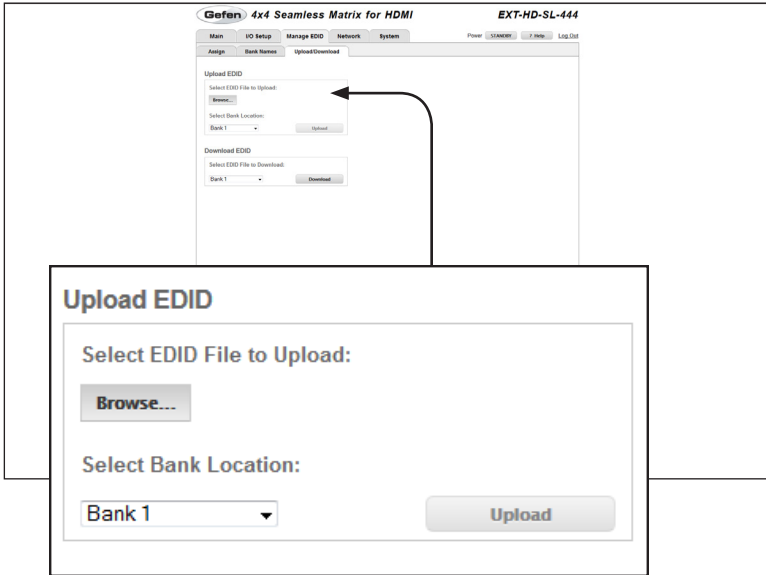

Browse...

Click this button to select the EDID file to be uploaded.

Select Bank Location

Click this drop-down list to select the bank to where the EDID will be uploaded.

Options
Bank 1 ... Bank 8

Upload

Click this button to upload the EDID to the specified bank.

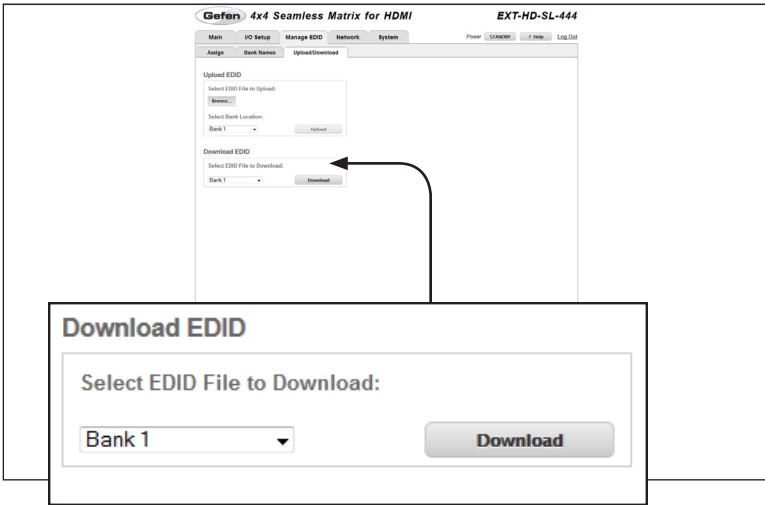

Select EDID File to Download

Click this box to select the EDID that is to be saved to a file. The EDID file will be saved in binary (.bin) format.

Options	
Bank 1	... Bank 8
1 - Output_1	... 4 - Output_4
1 - Input_1	... 4 - Input_4

Download

Click this button to download the selected EDID to a file.

Network

The screenshot shows the web interface for the Gefen 4x4 Seamless Matrix for HDMI (EXT-HD-SL-444). The 'Network' tab is selected. The IP Settings section is highlighted with a callout box. The callout box contains the following information:

IP Settings	
MAC Address	00:1C:91:02:20:03
Mode	Static
IP Address	192.168.1.72
Subnet	255.255.255.0
Gateway	192.168.1.254
HTTP Port	80

MAC Address

The MAC address of the matrix. The MAC address cannot be changed.

Mode

The network mode setting.

Options
Static
DHCP

IP Address

Enter the IP address of the matrix in this field. This option is only available if the network mode is set to *static*.

Subnet

Enter the subnet mask of the matrix in this field. This option is only available if the network mode is set to *static*.

Gateway

Enter the gateway (router) address in this field. This option is only available if the network mode is set to *static*.

HTTP

Enter the HTTP listening port in this field.

The screenshot shows the web interface for the Gefen 4x4 Seamless Matrix for HDMI (EXT-HD-SL-444). The 'Network' tab is selected, and the 'TCP/Telnet Settings' section is expanded. A callout box provides a detailed view of these settings:

TCP/Telnet Settings	
Enable TCP Access	<input checked="" type="checkbox"/>
Require Password on Connect	<input checked="" type="checkbox"/>
User Name	<input type="text" value="Admin"/>
Old Password	<input type="text"/>
New Password	<input type="text"/>

Enable TCP Access

Check this box to enable TCP access.

Require Password on Connect

Check this box to prompt the user for a password at the start of a Telnet session.

User Name

Enter the user name, required for login, in this field.

Old Password

Type the current (old) password in this field.

New Password

Type the new password in this field.

Gefen 4x4 Seamless Matrix for HDMI EXT-HD-SL-444

Main | **IO Setup** | Manage EIO | Network | System | Power | [STATUS](#) | [LOG Out](#)

IP Settings
 MAC Address: 60 1C 91 02 20 03
 Mode:
 IP Address: 192.168.1.129
 Subnet: 255.255.255.0
 Gateway: 192.168.1.254
 MTTP Port: 80

TCP/Netcat Settings
 Enable TCP Access:
 Require Password on Connect:
 User Name: Admin
 Old Password:
 New Password:
 Confirm New Password:
 Terminal Port: 23

UDP Settings
 Enable UDP Access:
 UDP Port:
 Enable UDP Echo:
 Destination UDP IP Address:
 Destination UDP Port:

Web Login Settings
 Username: Administrator
 Old Password:
 New Password:
 Confirm New Password:

[Set Network Defaults](#) [Save](#)

UDP Settings

Enable UDP Access

UDP Port

Enable UDP Echo

Destination UDP IP Address

Destination UDP Port

Enable UDP Access

Place a check mark in this box to enable UDP access.

UDP Port

Enter the UDP listening port in this field.

Enable UDP Echo

Place a check mark in this box to enable UDP echo.

Destination UDP IP Address

Enter the remote UDP IP address in this field.

Destination UDP Port

Enter the remote UDP listening port in this field.

The screenshot shows the web interface for the Gefen 4x4 Seamless Matrix for HDMI (EXT-HD-SL-444). The 'Network' tab is active, displaying various configuration options. A callout box titled 'Web Login Settings' is overlaid on the main interface, focusing on the 'Web Login Settings' section of the main page.

Web Login Settings

Username: Administrator

Old Password:

New Password:

Confirm New Password:

Buttons:

Username

Click this drop-down list to select the user name. The password for the selected user name can be changed, if desired.

Old Password

Type the current (old) password in this field.

New Password

Type the new password in this field.

Confirm Password

Re-type the new password in this field.

Set Network Defaults

Click to reset the network settings to factory-default.

Save

Click this button to save any network changes made on this page.

System

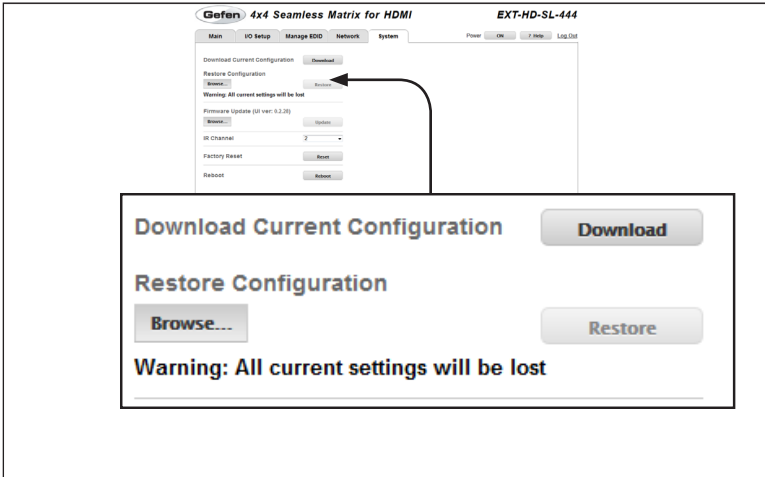

Download

Click this button to download the current matrix configuration to a file.

Browse...

Click this button to select the configuration file to be uploaded.

Restore

Uploads the selected configuration file to the matrix.

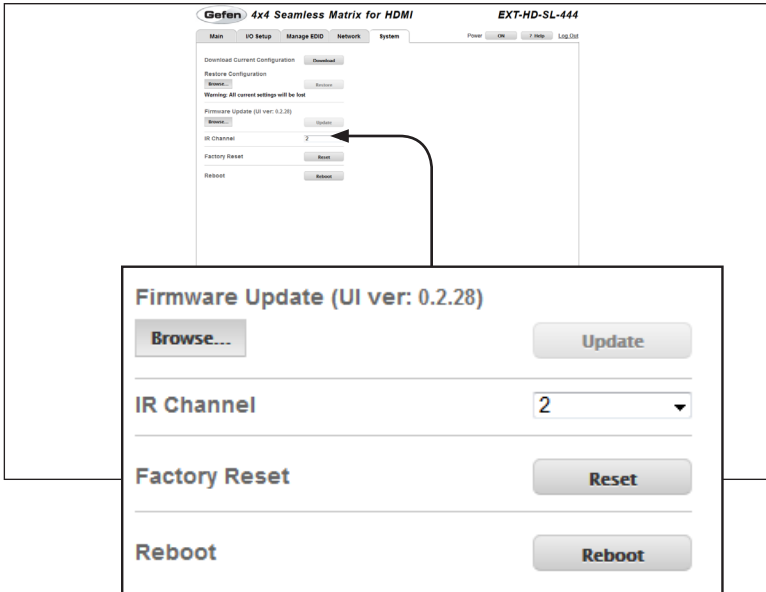
**Browse...**

Click this button to select the firmware file to be uploaded. See [Upgrading the Firmware](#) for more information.

Update

Click this button to begin the update process, once the firmware file is selected.

IR Channel

Click this drop-down list to set the desired IR channel for the matrix. The matrix and the included IR remote control must be set to the same channel in order to work properly.

**Reset**

Click this button to set the matrix to factory-default settings. The TCP/IP settings are preserved.

Reboot

Click this button to reboot the matrix.

4x4 Seamless Matrix for HDMI

04 Appendix

Upgrading the Firmware.....	142
Using the Web Interface.....	142
Using the USB Interface.....	143
Specifications	144

Upgrading the Firmware

Using the Web Interface



IMPORTANT: *DO NOT* power-off or disconnect the AC power cord from the matrix, at any time, during the firmware upgrade process.

1. Download the firmware update from the Support section of the Gefen Web site.
2. Extract the firmware file from the .ZIP file.
3. Power-ON the 4x4 Seamless Matrix for HDMI.
4. Connect an Ethernet cable between the matrix and the computer running the Web interface.

It is unnecessary to disconnect any cables or extenders from the 4x4 Seamless Matrix for HDMI during the update process.

5. Click the **Configuration** tab in the Web interface and click the **Browse...** button under the **System Configuration** section.
6. Select the firmware file and click the **Update** button.
7. The matrix will display a prompt to verify that the current firmware will be overwritten. Click the **OK** button on the dialog box to begin uploading the firmware file.
8. The 4x4 Seamless Matrix for HDMI will begin the upgrade process. This process will take several minutes. The upgrade process may be monitored using the RS-232 interface.
9. After the 4x4 Seamless Matrix for HDMI has been updated, the unit will automatically reboot.
10. After the 4x4 Seamless Matrix for HDMI reboots, the firmware upgrade process will be complete.

Using the USB Interface



IMPORTANT: *DO NOT* power-off or disconnect the AC power cord from the matrix, at any time, during the firmware upgrade process.

1. Download the firmware update from the Support section of the Gefen Web site.
2. Power-ON the 4x4 Seamless Matrix for HDMI.
3. Connect a USB cable between the computer and the 4x4 Seamless Matrix for HDMI.

It is unnecessary to disconnect any cables or extenders from the HD Video Wall Controller during the update process.
4. Once the computer is able to connect to the 4x4 Seamless Matrix for HDMI, a removable-disk icon will be displayed under My Computer.
5. Extract the firmware file from the .ZIP file and drag the .bin file to the Removable Disk.
6. Disconnect the USB cable from the computer.
7. After the 4x4 Seamless Matrix for HDMI has been updated, the unit will automatically reboot.
8. After the 4x4 Seamless Matrix for HDMI reboots, the firmware upgrade process will be complete.

Specifications

Supported Formats

Resolutions (max.)	<ul style="list-style-type: none"> • 1080p Full HD • 1920 x 1200 (WUXGA)
--------------------	--------------------------------------------------------------------------------------------------

Electrical

Maximum Pixel Clock	• 225 MHz
Preset Select Buttons	• 10 x Tact-type, blue backlight
Output Select Buttons	• 4 x Tact-type, blue backlight
Menu Button	• 1 x Tact-type, blue backlight
Menu Control Buttons	• 6 x Tact-type, blue backlight
On / Standby Button	• 1 x Tact-type, blue backlight
Standby Indicator	• 1 x LED, red
Input Indicators	• 20 x LED, blue

Connectors

Video Input	• 4 x HDMI Type A 19-pin, female, locking
Video Output	• 4 x HDMI Type A 19-pin, female, locking
RS-232	• 1 x DB-9, female
IP Control	• 1 x RJ-45
USB	• Mini-B
IR Extender	• 1 x 3.5mm mini-stereo
Power	• Locking-type

Operational

Power Input	• 12V DC
Power Consumption	• 24W (max.)

Physical

Dimensions (W x H x D)	• 16.9" x 1.7" x 7.9" (430mm x 42mm x 200mm)
Unit Weight	• 5.0 lbs (2.3 kg)



Stretch It, Switch It, Split It.
Gefen's Got It. ®

20600 Nordhoff St., Chatsworth CA 91311
1-800-545-6900 818-772-9100 fax: 818-772-9120
www.gefen.com support@gefen.com



This product uses UL or CE listed power supplies.